

# XS-82H XS-83H XS-84H

**MULTI-FORMAT MATRIX SWITCHER**

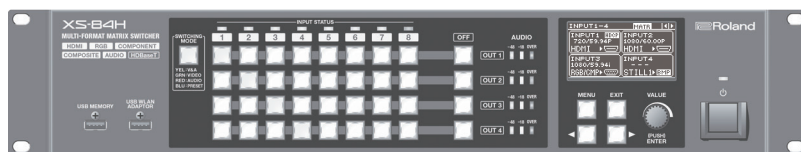
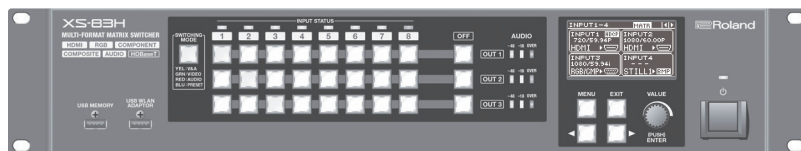
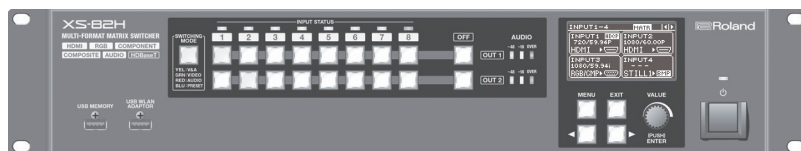

## Owner's Manual

### Owner's Manual (this document)

Read this first. It explains the basic things you need to know in order to use the XS-82H/XS-83H/XS-84H.

### PDF Manual (download from the Web)

- **Reference Manual**

This describes all parameters of the XS-82H/XS-83H/XS-84H. It also describes the settings to make when operating the unit by remote control.

**Copyright © 2014 ROLAND CORPORATION**

All rights reserved. No part of this publication may be reproduced in any form without the written permission of ROLAND CORPORATION.

### To obtain the PDF manual

**1. Enter the following URL in your computer.**  
<http://proav.roland.com>





**2. Go to the XS-82H, XS-83H, or XS-84H product page and click the "Support" tab.**

Before using the XS-82H/XS-83H/XS-84H, ensure that its system program is at the most recent version. For information on available upgrades for the system program, see the Roland website (<http://proav.roland.com>).

You can check the version of the system program by selecting the [MENU] button → "SYSTEM" → "VERSION."

**WARNING:** To reduce the risk of fire or electric shock, do not expose this apparatus to rain or moisture.

  
<b>ATTENTION:</b> RISQUE DE CHOC ELECTRIQUE NE PAS OUVRIR
<b>CAUTION:</b> TO REDUCE THE RISK OF ELECTRIC SHOCK, DO NOT REMOVE COVER (OR BACK). NO USER-SERVICEABLE PARTS INSIDE. REFER SERVICING TO QUALIFIED SERVICE PERSONNEL.



The lightning flash with arrowhead symbol, within an equilateral triangle, is intended to alert the user to the presence of uninsulated "dangerous voltage" within the product's enclosure that may be of sufficient magnitude to constitute a risk of electric shock to persons.



The exclamation point within an equilateral triangle is intended to alert the user to the presence of important operating and maintenance (servicing) instructions in the literature accompanying the product.

INSTRUCTIONS PERTAINING TO A RISK OF FIRE, ELECTRIC SHOCK, OR INJURY TO PERSONS.

## IMPORTANT SAFETY INSTRUCTIONS SAVE THESE INSTRUCTIONS

**WARNING** - When using electric products, basic precautions should always be followed, including the following:

1. Read these instructions.
2. Keep these instructions.
3. Heed all warnings.
4. Follow all instructions.
5. Do not use this apparatus near water.
6. Clean only with a dry cloth.
7. Do not block any of the ventilation openings. Install in accordance with the manufacturers instructions.
8. Do not install near any heat sources such as radiators, heat registers, stoves, or other apparatus (including amplifiers) that produce heat.
9. Do not defeat the safety purpose of the polarized or grounding-type plug. A polarized plug has two blades with one wider than the other. A grounding type plug has two blades and a third grounding prong. The wide blade or the third prong are provided for your safety. If the provided plug does not fit into your outlet, consult an electrician for replacement of the obsolete outlet.
10. Protect the power cord from being walked on or pinched particularly at plugs, convenience receptacles, and the point where they exit from the apparatus.
11. Only use attachments/accessories specified by the manufacturer.
12. Unplug this apparatus during lightning storms or when unused for long periods of time.
13. Refer all servicing to qualified service personnel. Servicing is required when the apparatus has been damaged in any way, such as power-supply cord or plug is damaged, liquid has been spilled or objects have fallen into the apparatus, the apparatus has been exposed to rain or moisture, does not operate normally, or has been dropped.

For the U.K.

**WARNING:** THIS APPARATUS MUST BE EARTHED

**IMPORTANT:** THE WIRES IN THIS MAINS LEAD ARE COLOURED IN ACCORDANCE WITH THE FOLLOWING CODE.  
GREEN-AND-YELLOW: EARTH, BLUE: NEUTRAL, BROWN: LIVE



As the colours of the wires in the mains lead of this apparatus may not correspond with the coloured markings identifying the terminals in your plug, proceed as follows:

The wire which is coloured GREEN-AND-YELLOW must be connected to the terminal in the plug which is marked by the letter E or by the safety earth symbol  or coloured GREEN or GREEN-AND-YELLOW.

The wire which is coloured BLUE must be connected to the terminal which is marked with the letter N or coloured BLACK.

The wire which is coloured BROWN must be connected to the terminal which is marked with the letter L or coloured RED.

**AVERTISSEMENT:** Pour éviter les risques d'incendie ou de choc électrique, ne pas exposer cet appareil à la pluie ou à l'humidité.

	<b>ATTENTION</b> RISQUE DE CHOC ÉLECTRIQUE NE PAS OUVRIR	
<b>ATTENTION: RISQUE DE CHOC ÉLECTRIQUE NE PAS OUVRIR</b>		
<b>ATTENTION: POUR ÉVITER LES RISQUES DE CHOC ÉLECTRIQUE, NE PAS OUVRIR LE COUVERCLE (OU L'ARRIÈRE). AUCUN DES ÉLÉMENTS INTERNES NE DOIT ÊTRE RÉPARÉ PAR L'UTILISATEUR. NE CONFIER L'ENTRETIEN QU'À UN PERSONNEL QUALIFIÉ.</b>		



L'éclair fêché dans un triangle équilatéral est destiné à avertir l'utilisateur de la présence, dans l'appareil, d'une zone non-isolée soumise à une « haute-tension » dont l'intensité est suffisante pour constituer un risque d'électrocution.



Le point d'exclamation dans un triangle équilatéral est destiné à attirer l'attention de l'utilisateur sur la présence d'informations de fonctionnement et maintenance (entretien) importantes dans la brochure accompagnant l'appareil.

## INSTRUCTIONS RELATIVES AUX RISQUES D'INCENDIE, DE CHOC ÉLECTRIQUE OU DE BLESSURES.

# INSTRUCTIONS IMPORTANTES DE SÉCURITÉ CONSERVER CES INSTRUCTIONS

**AVERTISSEMENT** - Lors de l'utilisation d'appareils électriques, des précautions de base doivent toujours être respectées, y compris ce qui suit :

1. Bien lire ces instructions.
2. Conserver ces instructions.
3. Tenir compte de tous les avertissements.
4. Suivre toutes ces instructions.
5. Ne pas utiliser pas l'appareil près de l'eau.
6. Nettoyer uniquement avec un chiffon sec.
7. Ne pas obstruer les ouïes de ventilation. Installer conformément aux instructions du fabricant.
8. Ne pas installer à proximité d'une source de chaleur telle qu'un radiateur, une bouche de chaleur, un poêle ou d'autres appareils (dont les amplificateurs) produisant de la chaleur.
9. Ne pas détériorer la sécurité de la fiche polarisée ou de la fiche de terre. Une fiche polarisée comporte deux lames dont l'une est plus large que l'autre. Une fiche de terre comporte deux lames et une troisième broche de mise à la terre. La lame la plus large ou la troisième broche assure la sécurité de l'utilisateur. Si la fiche fournie ne s'adapte pas à la prise électrique, demander à un électricien de remplacer la prise hors normes.
10. Protéger le cordon d'alimentation afin que personne ne marche dessus et que rien ne le pince, en particulier au niveau des fiches, des prises de courant et du point de sortie de l'appareil.
11. Utiliser uniquement les pièces / accessoires spécifiés par le fabricant.
12. Débrancher l'appareil pendant les orages ou quand il ne sera pas utilisé pendant longtemps.
13. Confier toute réparation à du personnel qualifié. Des réparations sont nécessaires si l'appareil est endommagé d'une façon quelconque, par exemple : cordon ou prise d'alimentation endommagé, liquide renversé ou objet tombé à l'intérieur de l'appareil, exposition de l'appareil à la pluie ou à l'humidité, appareil qui ne marche pas normalement ou que l'on a fait tomber.

# Contents

USING THE UNIT SAFELY .....	5
CONSIGNES DE SÉCURITÉ <b>French language</b> for Canadian Safety Standard .....	7
IMPORTANT NOTES .....	9
<b>Panel Descriptions</b> .....	10
Front Panel/Top Panel/Side Panel .....	10
Rear Panel .....	12
<b>Placement and Setup</b> .....	13
Important Notes on Rack Mounting .....	13
Attaching the Rubber Feet .....	13
Connecting Cables to the Euroblock Plugs .....	13
<b>Connecting External Equipment</b> .....	14
Connecting Video Source/Output Equipment .....	14
Connecting Audio Source/Output Equipment .....	15
Using Phantom Power .....	15
Connecting the Power Cord .....	16
<b>Basic Operation</b> .....	17
Turning the Power On and Off .....	17
Using the Menus .....	17
Changing the View on the Display .....	18
Changing Audio Fader Assignments .....	18
<b>Video Operations</b> .....	19
Setting the Video Signal for Each Video Input Channel .....	19
Sharing a Video Source (SHARE) .....	19
Changing Cross Points .....	19
Inputting/Outputting Copyright-protected (HDCP) Video .....	20
Switching Between HDMI Output and HDBaseT Output .....	21
Outputting an Imported Still Image .....	21
Switching the Video Output Mode .....	22
Applying a Fade to Output Video .....	24

<b>Audio Operations</b> .....	25
Adjusting Microphone Gain .....	25
Adjusting the Volume Balance of Input Audio .....	25
Adjusting the Volume Level of Output Audio .....	26
<b>Other Features</b> .....	27
Saving/Recalling Settings (Presets) .....	27
Saving Settings on a USB Flash Drive .....	27
Formatting USB Flash Drives .....	28
Returning Settings to the Factory-default State (Factory Reset) .....	28
Remote Control from an External Device .....	28
<b>Appendices</b> .....	29
Troubleshooting .....	29
Block Diagram .....	31
Connector Specifications .....	32
Analog video INPUT connectors .....	32
RS-232C connector .....	32
AUDIO INPUT/OUTPUT connectors .....	33
Main Specifications .....	34
Dimensions .....	36

\* Before using this unit, carefully read the sections entitled "IMPORTANT SAFETY INSTRUCTIONS" (p. 2), "USING THE UNIT SAFELY" (p. 5), and "IMPORTANT NOTES" (p. 9). These sections provide important information concerning the proper operation of the unit. Additionally, in order to feel assured that you have gained a good grasp of every feature of your new unit, read Owner's Manual in its entirety. This manual should be saved and kept on hand as a convenient reference.

\* The explanations of operation procedures in this document use illustrations of the XS-84H. Unless explicitly indicated to be for a specific model (such as "XS-84H only"), the explanations also cover the XS-82H and XS-83H as well.

## Checking the Included Items

The following items are included with this unit. Check to make sure that all items are present. If anything is missing, contact your dealer.

**The unit**



\* The appearance of each model differs.

**Power cord**



\* The shape of the power cord's plug varies depending on the country.

**Rubber foot (5)**



**Euroblock plug (12)**

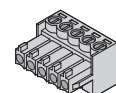

**Owner's Manual**

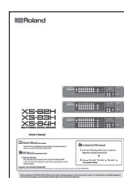



# USING THE UNIT SAFELY

## INSTRUCTIONS FOR THE PREVENTION OF FIRE, ELECTRIC SHOCK, OR INJURY TO PERSONS

### About ⚠ WARNING and ⚠ CAUTION Notices

<b>⚠ WARNING</b>	Used for instructions intended to alert the user to the risk of death or severe injury should the unit be used improperly.
<b>⚠ CAUTION</b>	Used for instructions intended to alert the user to the risk of injury or material damage should the unit be used improperly. * Material damage refers to damage or other adverse effects caused with respect to the home and all its furnishings, as well to domestic animals or pets.

### About the Symbols

	The ⚠ symbol alerts the user to important instructions or warnings. The specific meaning of the symbol is determined by the design contained within the triangle. In the case of the symbol at left, it is used for general cautions, warnings, or alerts to danger.
	The ⓧ symbol alerts the user to items that must never be carried out (are forbidden). The specific thing that must not be done is indicated by the design contained within the circle. In the case of the symbol at left, it means that the unit must never be disassembled.
	The ● symbol alerts the user to things that must be carried out. The specific thing that must be done is indicated by the design contained within the circle. In the case of the symbol at left, it means that the power-cord plug must be unplugged from the outlet.

## ALWAYS OBSERVE THE FOLLOWING

### ⚠ WARNING

#### Make sure that the power cord is grounded

Connect mains plug of this model to a mains socket outlet with a protective earthing connection.



#### To completely turn off power to the unit, pull out the plug from the outlet

Even with the power switch turned off, this unit is not completely separated from its main source of power. When the power needs to be completely turned off, turn off the power switch on the unit, then pull out the plug from the outlet. For this reason, the outlet into which you choose to connect the power cord's plug should be one that is within easy reach and readily accessible.



#### Secure a sufficient amount of space at the setup location

Since this unit normally emits a slight amount of heat, make sure to secure sufficient space around it, as shown below.

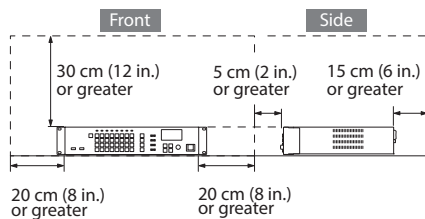

#### Do not disassemble or modify by yourself

Do not carry out anything unless you are instructed to do so in the owner's manual. Otherwise, you risk causing malfunction.



#### Do not repair or replace parts by yourself

Refer all servicing to your retailer, the nearest Roland Service Center, or an authorized Roland distributor, as listed on the "Information."



### ⚠ WARNING

#### Do not use or store in the following types of locations

- Subject to temperature extremes (e.g., direct sunlight in an enclosed vehicle, near a heating duct, on top of heat-generating equipment); or are
- Damp (e.g., baths, washrooms, on wet floors); or are
- Exposed to steam or smoke; or are
- Subject to salt exposure; or are
- Exposed to rain; or are
- Dusty or sandy; or are
- Subject to high levels of vibration and shakiness.



#### Do not place in an unstable location

Otherwise, you risk injury as the result of the unit toppling over or dropping down.



#### Use only the supplied power cord

Use only the attached power cord. Also, the supplied power cord must not be used with any other device.



#### Connect the power cord to an outlet of the correct voltage

The unit should be connected to a power supply only of the type described in the operating instructions, or as marked on the rear side of unit.



#### Do not bend the power cord or place heavy objects on it

Otherwise, fire or electric shock may result.



#### Avoid extended use at high volume

Use of the unit at high volume for extended periods of time may cause hearing loss. If you ever experience any hearing loss or ringing in the ears, you should immediately stop using the unit and consult a specialized physician.



### ⚠ WARNING

#### Do not allow foreign objects or liquids to enter unit; never place containers with liquid on unit

Do not place containers containing liquid (e.g., flower vases) on this product. Never allow foreign objects (e.g., flammable objects, coins, wires) or liquids (e.g., water or juice) to enter this product. Doing so may cause short circuits, faulty operation, or other malfunctions.



#### Turn off the unit if an abnormality or malfunction occurs

Immediately turn the unit off, remove the power cord from the outlet, and request servicing by your retailer, the nearest Roland Service Center, or an authorized Roland distributor, as listed on the "Information" when:



- The power cord has been damaged; or
- If smoke or unusual odor occurs; or
- Objects have fallen into, or liquid has been spilled onto the unit; or
- The unit has been exposed to rain (or otherwise has become wet); or
- The unit does not appear to operate normally or exhibits a marked change in performance.

#### Do not drop or subject to strong impact

Otherwise, you risk causing damage or malfunction.



#### Do not share an outlet with an unreasonable number of other devices

Otherwise, you risk overheating or fire.



#### Do not use overseas

Before using the unit in overseas, consult with your retailer, the nearest Roland Service Center, or an authorized Roland distributor, as listed on the "Information."



### CAUTION

#### Place in a well ventilated location

The unit should be located so that its location or position does not interfere with its proper ventilation.



#### When disconnecting the power cord, grasp it by the plug

To prevent conductor damage, always grasp the power cord by its plug when disconnecting it from this unit or from a power outlet.



#### Periodically clean the power plug

An accumulation of dust or foreign objects between the power plug and the power outlet can lead to fire or electric shock.



At regular intervals, be sure to pull out the power plug, and using a dry cloth, wipe away any dust or foreign objects that may have accumulated.

#### Disconnect the power plug whenever the unit will not be used for an extended period of time

Fire may result in the unlikely event that a breakdown occurs.



#### Route all power cords and cables in such a way as to prevent them from getting entangled

Injury could result if someone were to trip on a cable and cause the unit to fall or topple.



#### Avoid climbing on top of the unit, or placing heavy objects on it

Otherwise, you risk injury as the result of the unit toppling over or dropping down.



#### Never connect/disconnect a power plug if your hands are wet

Otherwise, you could receive an electric shock.



#### Disconnect all cords/cables before moving the unit

Before moving the unit, disconnect the power plug from the outlet, and pull out all cords from external devices.



#### Before cleaning the unit, disconnect the power plug from the outlet

If the power plug is not removed from the outlet, you risk receiving an electric shock.



#### Whenever there is a threat of lightning, disconnect the power plug from the outlet

If the power plug is not removed from the outlet, you risk receiving an electric shock.



#### Precautions concerning use of phantom power supply



Always turn the phantom power off when connecting any device other than condenser microphones that require phantom power. You risk causing damage if you mistakenly supply phantom power to dynamic microphones, audio playback devices, or other devices that don't require such power. Be sure to check the specifications of any microphone you intend to use by referring to the manual that came with it.





(This instrument's phantom power: 48 V DC, 14 mA Max)

## INSTRUCTIONS POUR LA PRÉVENTION DES INCENDIES, CHOCS ÉLECTRIQUES OU BLESSURES

À propos des mentions ⚠ AVERTISSEMENT  
et ⚠ ATTENTION

 <b>AVERTISSEMENT</b>	Utilisé pour avertir l'utilisateur d'un risque de décès ou de blessure grave en cas de mauvaise utilisation de l'appareil.
 <b>ATTENTION</b>	Utilisé pour avertir l'utilisateur d'un risque de blessure ou de dommage matériel en cas de mauvaise utilisation de l'appareil.  * Par dommage matériel, il est entendu les dommages ou tout autre effet indésirable sur la maison et tous ses meubles ainsi que les animaux domestiques ou familiers.

À propos des symboles

	Le symbole ⚠ alerte l'utilisateur d'instructions importantes ou de mise en garde. La signification du symbole est déterminée par ce que contient le triangle. Dans le cas du symbole de gauche, il sert pour des précautions générales, des mises en garde ou alertes vis-à-vis d'un danger.
	Le symbole ⚡ prévient l'utilisateur des choses à ne pas faire (des interdits). Ce qui ne doit spécifiquement pas être fait est indiqué dans le cercle. Dans le cas du symbole de gauche, cela signifie que l'appareil ne doit jamais être démonté.
	Le symbole ● alerte l'utilisateur des choses à faire. Ce qui doit être fait est indiqué par l'icône contenue dans le cercle. Dans le cas du symbole de gauche, cela signifie que le cordon d'alimentation doit être débranché de la prise murale.

## PROCÉDEZ TOUJOURS COMME SUIV

### AVERTISSEMENT

#### S'assurer que le cordon d'alimentation est bien mis à la terre

Connectez la fiche secteur de ce modèle à une prise de courant dotée d'une protection par mise à la terre.



#### Pour éteindre complètement l'alimentation de l'appareil, retirer la fiche de la prise

Même avec son interrupteur d'alimentation hors tension, l'appareil n'est pas complètement isolé de sa source principale d'alimentation. Lorsque l'alimentation doit être complètement coupée, éteignez l'interrupteur d'alimentation de l'appareil puis retirez la fiche de la prise. Pour cette raison, la prise dans laquelle vous choisissez de brancher la fiche du cordon d'alimentation doit être proche et facilement accessible.



#### Ménager un espace suffisant à l'emplacement d'installation

Comme l'appareil émet normalement une faible quantité de chaleur, assurez-vous de ménager suffisamment d'espace autour de lui, comme indiqué ci-dessous.

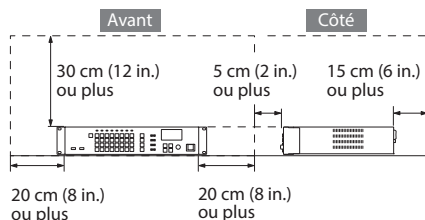

#### Ne jamais démonter ou modifier vous-même

Ne jamais effectuer une quelconque opération, sauf si vous êtes invité à le faire dans le manuel du propriétaire. Sinon, vous risquez de provoquer des dysfonctionnements.



#### Ne pas réparer ou remplacer de pièces par vous-même

Confiez toute réparation à votre revendeur, le centre Roland le plus proche ou un distributeur Roland agréé, comme indiqué dans les « Informations ».



### AVERTISSEMENT

#### Ne jamais ranger ou utiliser dans des endroits:

- Soumis à des températures extrêmes (ex : en plein soleil dans un véhicule fermé, à proximité d'une conduite de chauffage, au-dessus de matériel générateur de chaleur),
- humides (ex : salles de bain, toilettes, sur des sols mouillés), ou
- exposés à de la vapeur ou de la fumée, ou
- exposés au sel, ou
- exposés aux précipitations, ou
- poussiéreux ou sableux, ou
- soumis à de fortes vibrations et secousses.



#### Ne pas placer à un endroit instable

Sinon, vous risquez des blessures si l'appareil se renverse ou tombe.



#### Utilisez uniquement le cordon d'alimentation fourni

Utilisez exclusivement le cordon d'alimentation inclus. De plus, le cordon d'alimentation fourni ne doit pas être utilisé avec un autre appareil.



#### Brancher le cordon d'alimentation à une prise d'une tension correcte

L'appareil doit être connecté à une source d'alimentation du type décrit dans les instructions d'utilisation, ou comme indiqué sur la face arrière de l'appareil.



#### Ne pas plier le cordon d'alimentation ou déposer d'objets lourds sur celui-ci

Sinon, cela risque de provoquer un incendie ou un choc électrique.



#### Éviter l'utilisation prolongée à un volume élevé

L'utilisation de l'appareil à un volume élevé pendant des périodes prolongées peut entraîner une perte auditive. Si jamais vous ressentez une perte auditive ou des bourdonnements dans les oreilles, veuillez immédiatement cesser d'utiliser l'appareil et consultez un médecin spécialisé.



### AVERTISSEMENT

#### Ne jamais laisser de corps étrangers ou de liquides pénétrer dans l'appareil et ne jamais placer de récipients contenant un liquide sur l'appareil

Ne jamais placer de récipients contenant du liquide (ex : vases de fleurs) sur ce produit. Ne jamais laisser des corps étrangers (ex : objets inflammables, pièces, fils) ou des liquides (ex : eau, jus de fruit) pénétrer à l'intérieur du produit. Vous risqueriez de provoquer des courts-circuits, pannes ou autres dysfonctionnements.



#### Eteindre l'appareil en cas d'anomalie ou de dysfonctionnement

Mettez immédiatement l'appareil hors tension, débranchez le cordon d'alimentation de la prise et contactez votre revendeur, le centre Roland le plus proche ou un distributeur Roland agréé, comme indiqué dans les « Informations » lorsque:



- Le cordon d'alimentation a été endommagé, ou
- en présence de fumée ou odeur inhabituelle, ou
- des objets sont tombés dans ou du liquide a été renversé dans l'appareil, ou
- l'appareil a été exposé à la pluie (ou a été mouillé), ou
- l'appareil ne semble pas fonctionner normalement ou présente un changement notable de ses performances.

#### Ne pas faire tomber ou soumettre à des chocs violents

Sinon, vous risquez de provoquer des dommages ou des dysfonctionnements.



#### Ne pas partager une prise murale avec un nombre excessif d'autres appareils

Sinon, vous risquez une surchauffe ou un incendie.



#### Ne pas utiliser à l'étranger

Avant d'utiliser l'appareil à l'étranger, consultez votre revendeur, un centre Roland ou un distributeur Roland agréé, comme indiqué dans les « informations ».



**! ATTENTION**

**Placer dans un endroit bien ventilé**

L'appareil doit être placé en veillant à ce que son emplacement ou sa position ne gêne pas sa propre ventilation.



**Lorsque vous débranchez le cordon d'alimentation, saisissez-le par la fiche**

Pour éviter d'endommager le conducteur, toujours saisir le cordon d'alimentation par sa fiche lorsque vous le débranchez de l'appareil ou d'une prise de courant.



**Nettoyer régulièrement le cordon d'alimentation**

Une accumulation de poussière ou de corps étrangers entre la fiche d'alimentation et la prise de courant peut provoquer un incendie ou un choc électrique.



A intervalles réguliers, assurez-vous de débrancher la prise d'alimentation, et à l'aide d'un chiffon sec, essuyez la poussière ou les corps étrangers qui ont pu s'y accumuler.

**Débrancher le cordon d'alimentation lorsque l'appareil n'est pas utilisé pendant une longue période**

Un incendie peut se produire dans le cas fortuit où une panne survient.



**Acheminer tous les cordons d'alimentation et câbles de façon à ce qu'ils ne puissent pas s'emmêler**

Des blessures peuvent survenir si quelqu'un vient à trébucher sur un câble et provoque la chute ou le basculement de l'appareil.



**Ne pas grimper sur l'appareil ou y poser des objets lourds**

Sinon, vous risquez des blessures suite à la chute ou au basculement de l'appareil.



**Ne jamais brancher / débrancher un cordon d'alimentation lorsque vous avez les mains mouillées**

Sinon, vous pourriez subir un choc électrique.



**Débrancher tous les cordons / câbles avant de déplacer l'appareil**

Avant de déplacer l'appareil, débrancher le cordon d'alimentation de la prise et retirer tous les cordons des appareils externes.



**Avant de nettoyer l'appareil, débrancher le cordon d'alimentation de la prise**

Si la fiche d'alimentation n'est pas débranchée de la prise, vous risquez de subir un choc électrique.



**Chaque fois qu'il y a un risque de foudre, débrancher le cordon d'alimentation de la prise**

Si la fiche d'alimentation n'est pas débranchée de la prise, vous risquez de subir un choc électrique.



**! ATTENTION**

**Précautions concernant l'utilisation de l'alimentation fantôme**

Toujours éteindre l'alimentation fantôme avant de brancher tout autre appareil qu'un microphone à condensateur nécessitant une alimentation fantôme.



Vous risquez de provoquer des dommages si vous fournissez à tort une alimentation fantôme à des micros dynamiques, des appareils de lecture audio ou d'autres appareils qui ne nécessitent pas une telle alimentation. Assurez-vous de vérifier les spécifications de tout microphone que vous souhaitez utiliser en vous référant au manuel qui l'accompagne.

(Alimentation fantôme de cet instrument: 48 V DC, 14 mA Max)

# IMPORTANT NOTES

## Power Supply

- Do not connect this unit to same electrical outlet that is being used by an electrical appliance that is controlled by an inverter or a motor (such as a refrigerator, washing machine, microwave oven, or air conditioner). Depending on the way in which the electrical appliance is used, power supply noise may cause this unit to malfunction or may produce audible noise. If it is not practical to use a separate electrical outlet, connect a power supply noise filter between this unit and the electrical outlet.

## Placement

- Using the unit near power amplifiers (or other equipment containing large power transformers) may induce hum. To alleviate the problem, change the orientation of this unit; or move it farther away from the source of interference.
- This unit may interfere with radio and television reception. Do not use this unit in the vicinity of such receivers.
- Noise may be produced if wireless communications devices, such as cell phones, are operated in the vicinity of this unit. Such noise could occur when receiving or initiating a call, or while conversing. Should you experience such problems, you should relocate such wireless devices so they are at a greater distance from this unit, or switch them off.
- Do not expose the unit to direct sunlight, place it near devices that radiate heat, leave it inside an enclosed vehicle, or otherwise subject it to temperature extremes. Excessive heat can deform or discolor the unit.
- When moved from one location to another where the temperature and/or humidity is very different, water droplets (condensation) may form inside the unit. Damage or malfunction may result if you attempt to use the unit in this condition. Therefore, before using the unit, you must allow it to stand for several hours, until the condensation has completely evaporated.
- Depending on the material and temperature of the surface on which you place the unit, its rubber feet may discolor or mar the surface. You can place a piece of felt or cloth under the rubber feet to prevent this from happening. If you do so, please make sure that the unit will not slip or move accidentally.
- Do not place containers or anything else containing liquid on top of this unit. Also, whenever any liquid has been spilled on the surface of this unit, be sure to promptly wipe it away using a soft, dry cloth.

## Maintenance

- For everyday cleaning wipe the unit with a soft, dry cloth or one that has been slightly dampened with water. To remove stubborn dirt, use a cloth impregnated with a mild, non-abrasive detergent. Afterwards, be sure to wipe the unit thoroughly with a soft, dry cloth.
- Never use benzene, thinners, alcohol or solvents of any kind, to avoid the possibility of discoloration and/or deformation.

## Repairs and Data

- Before sending the unit away for repairs, be sure to make a backup of the data stored within it; or you may prefer to write down the needed information. Although we will do our utmost to preserve the data stored in your unit when we carry out repairs, in some cases, such as when the memory section is physically damaged, restoration of the stored content may be impossible. Roland assumes no liability concerning the restoration of any stored content that has been lost.

## Additional Precautions

- Any data stored within the unit can be lost as the result of equipment failure, incorrect operation, etc. To protect yourself against the irretrievable loss of data, try to make a habit of creating regular backups of the data you've stored in the unit.
- Roland assumes no liability concerning the restoration of any stored content that has been lost.
- Use a reasonable amount of care when using the unit's buttons, sliders, or other controls; and when using its jacks and connectors. Rough handling can lead to malfunctions.
- When disconnecting all cables, grasp the connector itself—never pull on the cable. This way you will avoid causing shorts, or damage to the cable's internal elements.
- A small amount of heat will radiate from the unit during normal operation.
- To avoid disturbing others nearby, try to keep the unit's volume at reasonable levels.
- When you need to transport the unit, pack it in shock-absorbent material. Transporting the unit without doing so can cause it to become scratched or damaged, and could lead to malfunction.
- This unit allows you to switch images at high speed. For some people, viewing such images can cause headache, nausea, or other discomfort. Do not use this unit to create video that might cause these types of health problems. Roland Corporation will accept no responsibility for any such health problems that may occur in yourself or in viewers.

## Using External Memories

- Please observe the following precautions when handling external memory devices. Also, make sure to carefully observe all the precautions that were supplied with the external memory device.
  - Do not remove the device while reading/writing is in progress.
  - To prevent damage from static electricity, discharge all static electricity from your person before handling the device.

## Intellectual Property Right

- This product can be used to record or duplicate audio or visual material without being limited by certain technological copy-protection measures. This is due to the fact that this product is intended to be used for the purpose of producing original music or video material, and is therefore designed so that material that does not infringe copyrights belonging to others (for example, your own original works) can be recorded or duplicated freely.
- MMP (Moore Microprocessor Portfolio) refers to a patent portfolio concerned with microprocessor architecture, which was developed by Technology Properties Limited (TPL). Roland has licensed this technology from the TPL Group.
- Roland is an either registered trademark or trademark of Roland Corporation in the United States and/or other countries.
- Company names and product names appearing in this document are registered trademarks or trademarks of their respective owners.

# Panel Descriptions

## Front Panel/Top Panel/Side Panel

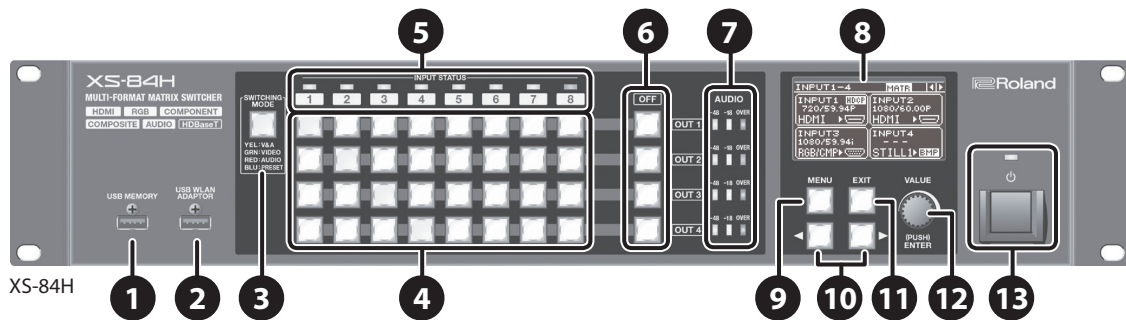

No.	Name	Explanation	Page										
1	USB MEMORY connector	This is for connecting a USB flash drive. You use this when saving or loading settings, or when importing still images.	p. 21 p. 27										
2	USB WLAN ADAPTOR connector	Here you connect a wireless USB adapter (sold separately) for making a Wi-Fi connection to an iPad. You use this when operating the unit remotely using the XS-80H Remote iPad application. * For the wireless USB adaptor, use the ONKYO UWF-1 or Roland WNA1100-RL.	p. 28										
3	[SWITCHING MODE] button	This switches the operation mode of the cross-point selection buttons (4). Successive presses of the button cycle through the modes in this sequence: video and audio interlink mode → video independent mode → audio independent mode → preset mode. The color of the lighted button indicates the operation mode. <ul style="list-style-type: none"> <li>Lighted in yellow: Video and audio interlink mode</li> <li>Lighted in green: Video independent mode</li> <li>Lighted in red: Audio independent mode</li> <li>Lighted in blue: Preset mode</li> </ul>	p. 19 p. 27										
4	Cross-point selection buttons	These function as follows, according to the operation mode selected using the [SWITCHING MODE] button (3). <table border="1" style="width: 100%; border-collapse: collapse;"> <thead> <tr> <th>Operation mode</th> <th>Functioning of the cross-point selection buttons</th> </tr> </thead> <tbody> <tr> <td>Video and audio interlink mode</td> <td>These switch the cross points for the video or audio channels. According to the operation mode, they can switch the video and audio in tandem, or independently switch only the video or only the audio.</td> </tr> <tr> <td>Video independent mode</td> <td>Each button's horizontal direction is the input channel and vertical direction is the output channel. The current selection of audio or video channel is indicated by the color of the lighted button. <ul style="list-style-type: none"> <li>Lighted in yellow: Video channel and audio channel</li> <li>Lighted in green: Video channel only</li> <li>Lighted in red: Audio channel only</li> </ul> </td> </tr> <tr> <td>Audio independent mode</td> <td></td> </tr> <tr> <td>Preset mode</td> <td>These function as memory-number selection buttons. These buttons access preset settings that have been saved.</td> </tr> </tbody> </table>	Operation mode	Functioning of the cross-point selection buttons	Video and audio interlink mode	These switch the cross points for the video or audio channels. According to the operation mode, they can switch the video and audio in tandem, or independently switch only the video or only the audio.	Video independent mode	Each button's horizontal direction is the input channel and vertical direction is the output channel. The current selection of audio or video channel is indicated by the color of the lighted button. <ul style="list-style-type: none"> <li>Lighted in yellow: Video channel and audio channel</li> <li>Lighted in green: Video channel only</li> <li>Lighted in red: Audio channel only</li> </ul>	Audio independent mode		Preset mode	These function as memory-number selection buttons. These buttons access preset settings that have been saved.	p. 19 p. 27
Operation mode	Functioning of the cross-point selection buttons												
Video and audio interlink mode	These switch the cross points for the video or audio channels. According to the operation mode, they can switch the video and audio in tandem, or independently switch only the video or only the audio.												
Video independent mode	Each button's horizontal direction is the input channel and vertical direction is the output channel. The current selection of audio or video channel is indicated by the color of the lighted button. <ul style="list-style-type: none"> <li>Lighted in yellow: Video channel and audio channel</li> <li>Lighted in green: Video channel only</li> <li>Lighted in red: Audio channel only</li> </ul>												
Audio independent mode													
Preset mode	These function as memory-number selection buttons. These buttons access preset settings that have been saved.												
5	INPUT STATUS indicators	These indicate the type of video signal being input. <ul style="list-style-type: none"> <li>Lighted in blue: HDMI signal</li> <li>Lighted in red: Analog video signal (RGB/component, composite, Y/C)</li> <li>Lighted up in white: Still picture</li> <li>Dark: No input signal</li> </ul>	p. 19										
6	[OFF] buttons	These apply fade to the output video and output a picture of a single color (specifiable). The corresponding [OFF] button lights up when the video fade-out is complete.	p. 24										
7	AUDIO level meters	These indicate the volume levels on the output channels.	p. 26										
8	Display	These display information about input and output video, menu items, and the like.	p. 18										



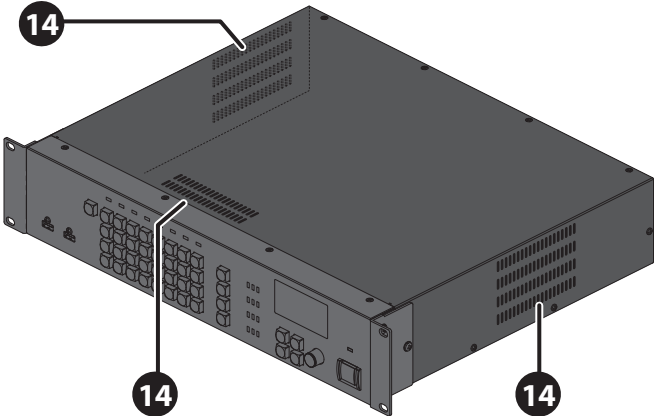

No.	Name	Explanation	Page
9	[MENU] button	This displays the menu.	p. 17
10	[◀][▶] (cursor) buttons	<ul style="list-style-type: none"> <li>• During menu display, these move the cursor. Also, depending on the menu item, they move to the setting screen for a different channel or the like.</li> <li>• These change the view mode for the top screen of the display.</li> </ul>	p. 17 p. 18
11	[EXIT] button	This exits the menus. When the system is at a lower-level menu, these return operation to the upper menu.	p. 17
12	[VALUE] knob	This selects menu items and changes setting values. Pressing the [VALUE] dial applies a selected menu item or changes made to a setting value.	p. 17
13	Power indicator	This indicates the power state. <ul style="list-style-type: none"> <li>• Lighted in red: Standby</li> <li>• Lighted in green: Powered</li> <li>• Dark: Main power off</li> </ul>	p. 17
	Power button	This switches the power between on and standby. * This is enabled only when the [POWER] (main power) switch is set to "ON."	
14	Cooling-fan exhaust port	This expels internal heat to keep temperatures inside the unit from rising excessively. <b>NOTE</b> Never block the cooling-fan exhaust port. Blocking the exhaust port might result in a rise in temperature inside the unit, resulting in malfunction due to heat.	—



## Rear Panel

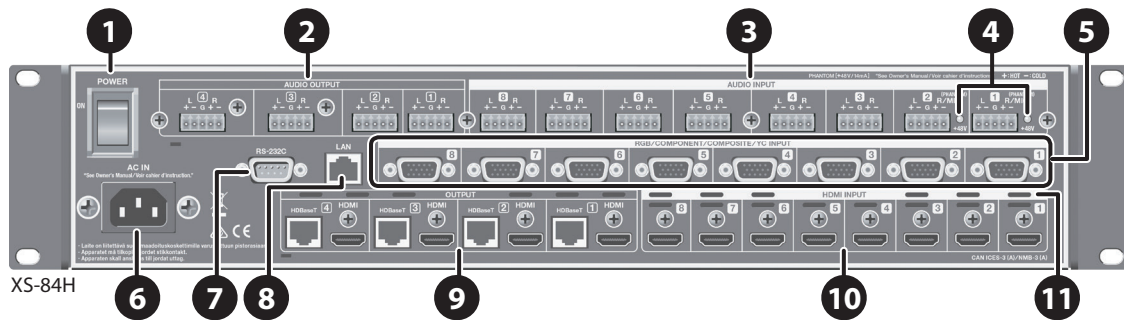

No.	Name	Explanation	Page
1	[POWER] (main power) switch	This turns the main power on and off. When the main power has been turned on, the power button on the front panel can be used to switch the power to on or standby.	p. 17
2	AUDIO OUTPUT connectors	These are 5p Euroblock connectors for output of analog audio signals. Recording units, power amps, speakers, and other devices are connected to these. * To make connections, use the included Euroblock plugs (p. 13).	p. 14
3	AUDIO INPUT connectors	These are 5p Euroblock connectors for input of analog audio signals. You connect audio decks, microphones, and other such devices to these. * To make connections, use the included Euroblock plugs (p. 13). * AUDIO INPUT connectors 1 and 2 can supply phantom power (+48 V).	p. 14
4	Phantom power indicator	This indicator lights up when phantom power (+48 V) is turned on.	p. 14
5	Analog video INPUT connectors (RGB/COMPONENT/COMPOSITE/YC INPUT connectors)	These are D-Sub 15-pin connectors for input of analog video signals. In addition to RGB signals, using conversion cables lets you input component, composite, and Y/C (S-Video) signals. You connect video decks, computers, and other such devices to these. * Inputting video requires setting the type of video signal (RGB/component, composite, or Y/C) for each input video channel.	p. 14
6	AC IN connector	This is for connecting the included power cord.	p. 16
7	RS-232C connector	This is for connecting a remote-control device (such as an RS-232C-compatible computer) for operating the unit remotely.	p. 28
8	LAN port	This is for connecting a computer or other network-capable equipment for operating the unit remotely.	p. 28
9	HDMI OUTPUT connectors	These output HDMI signals. External displays or other devices equipped with HDMI input connectors are connected to these. * Simultaneously outputting video from both the HDMI output connector and the HDBaseT output connector on the same channel is not possible.	p. 14 p. 21
	HDBaseT OUTPUT connectors	These output HDBaseT signals. Projectors or other devices equipped with HDBaseT input connectors are connected to these. * To make connections, use a Cat 5e (Category 5e) or later shielded LAN cable.	
10	HDMI INPUT connectors	These are for inputting HDMI signals. Video devices equipped with HDMI output connectors are connected to these. * Inputting video requires setting the type of video signal (HDMI) for each input video channel.	p. 15
11	Cooling-fan exhaust port	This expels internal heat to keep temperatures inside the unit from rising excessively. <b>NOTE</b> Never block the cooling-fan exhaust port. Blocking the exhaust port might result in a rise in temperature inside the unit, resulting in malfunction due to heat.	—

# Placement and Setup

## Important Notes on Rack Mounting

- \* When mounting the unit in a rack, to ensure efficient cooling, give attention to the following points.
  - Install in a well-ventilated location.
  - Never obstruct the exhaust ports on the unit's top, rear, and side panels.
  - Avoid mounting the unit in a sealed-type rack. Warm air within the rack cannot escape and is sucked into the unit, making efficient cooling impossible.
  - If the back of the rack cannot be opened, install an exhaust port or ventilation fan at the top back surface of the rack, where warm air collects.
  - When using the unit while mounted in a movable case (portable rack), remove the front and rear rack covers so that the front and back of the unit are not obstructed.
- \* When installing the unit in a rack or the like, use the mounting screws occupying the screw holes in the rack-mount brackets (included with the unit). Also, use due caution to ensure that your fingers don't get pinched.
- \* Also read the "Placement" section (p. 9) under "IMPORTANT NOTES."

## Attaching the Rubber Feet

When using the unit with it unmounted in a rack, attach the included rubber feet (5) if necessary.

1. Peel off the double-sided tape from the rubber feet and affix the rubber feet at the locations shown in the figure.

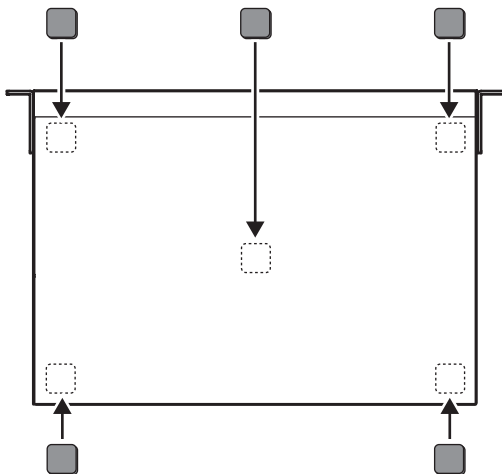

## Connecting Cables to the Euroblock Plugs

Attach cables to the included Euroblock plug and connect them to the AUDIO INPUT and OUTPUT connectors.

### 1. Prepare the cables.

Strip off about 5 mm of insulation from the tip of each cable and tightly twist the core wires.

- \* To avoid electromagnetic noise and other such trouble, we recommend using shielded cables.



#### NOTE

Never apply solder to the insulation-stripped section of the cable.

### 2. Attach the cable to the Euroblock plug.

Use a commercially available flathead screwdriver to loosen the connector screw.

Insert the cable prepared in step 1, then secure it in place by tightening the connector screw using the flathead screwdriver.

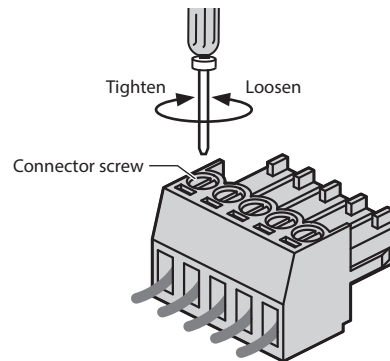

## Important Notes When Wiring

The AUDIO INPUT and OUTPUT connectors are wired as shown in the figure below.

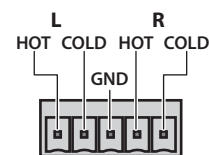

Wire the cables correctly, according to whether you're using balanced or unbalanced connections.

- \* For information on how to carry out wiring, refer to "AUDIO INPUT/OUTPUT connectors" (p. 33).

3. Insert the Euroblock plug into the AUDIO INPUT or OUTPUT connector on the unit.

# Connecting External Equipment

- \* To prevent malfunction and equipment failure, always turn down the volume, and turn off all the units before making any connections.
- \* Provide cable and adapter plugs to match the connector configuration on the equipment you're using.

## Connecting Video Source/Output Equipment

After making the connections, make the settings for the type of incoming video signals on video channels 1 through 8 (p. 19).

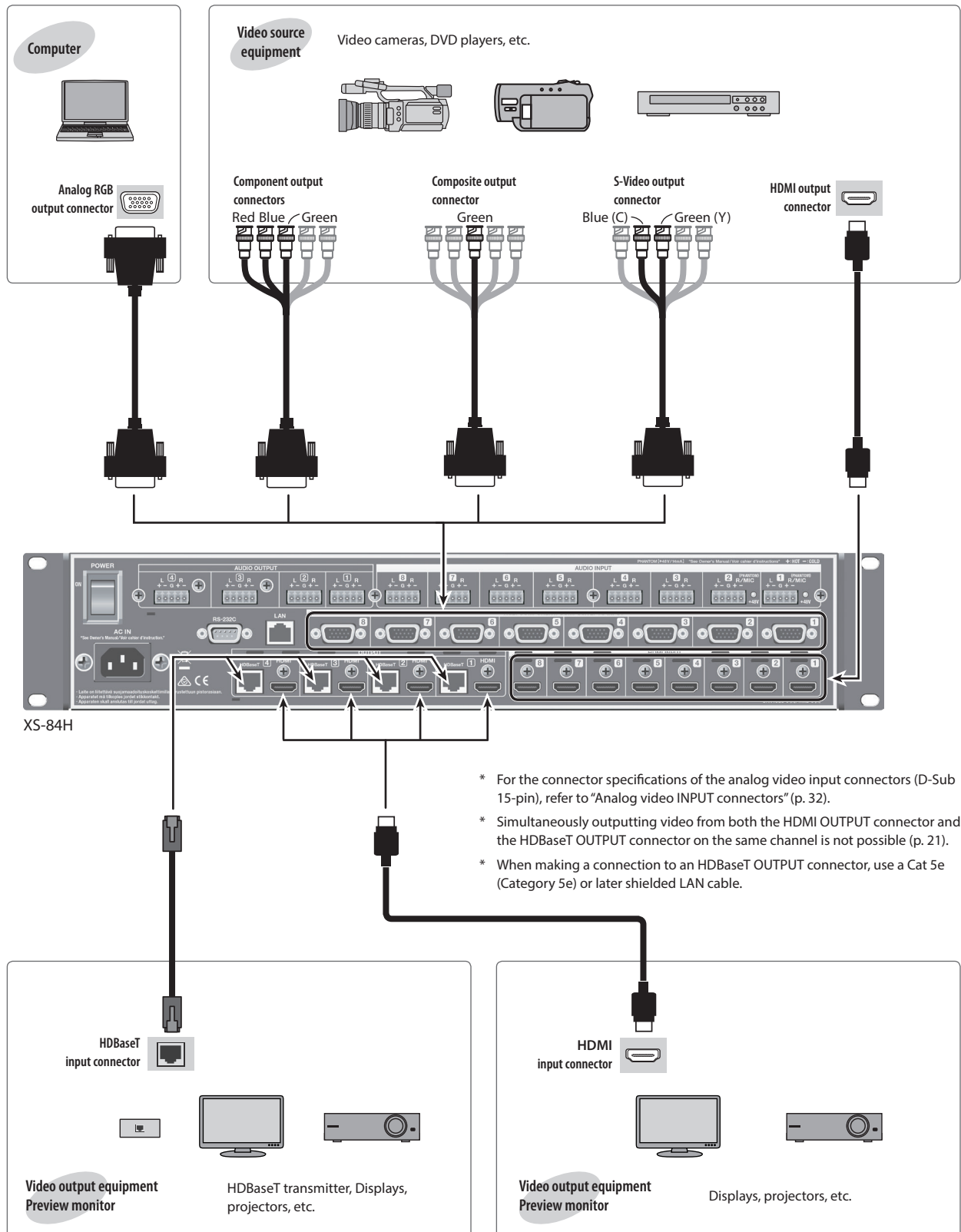

# Connecting Audio Source/Output Equipment

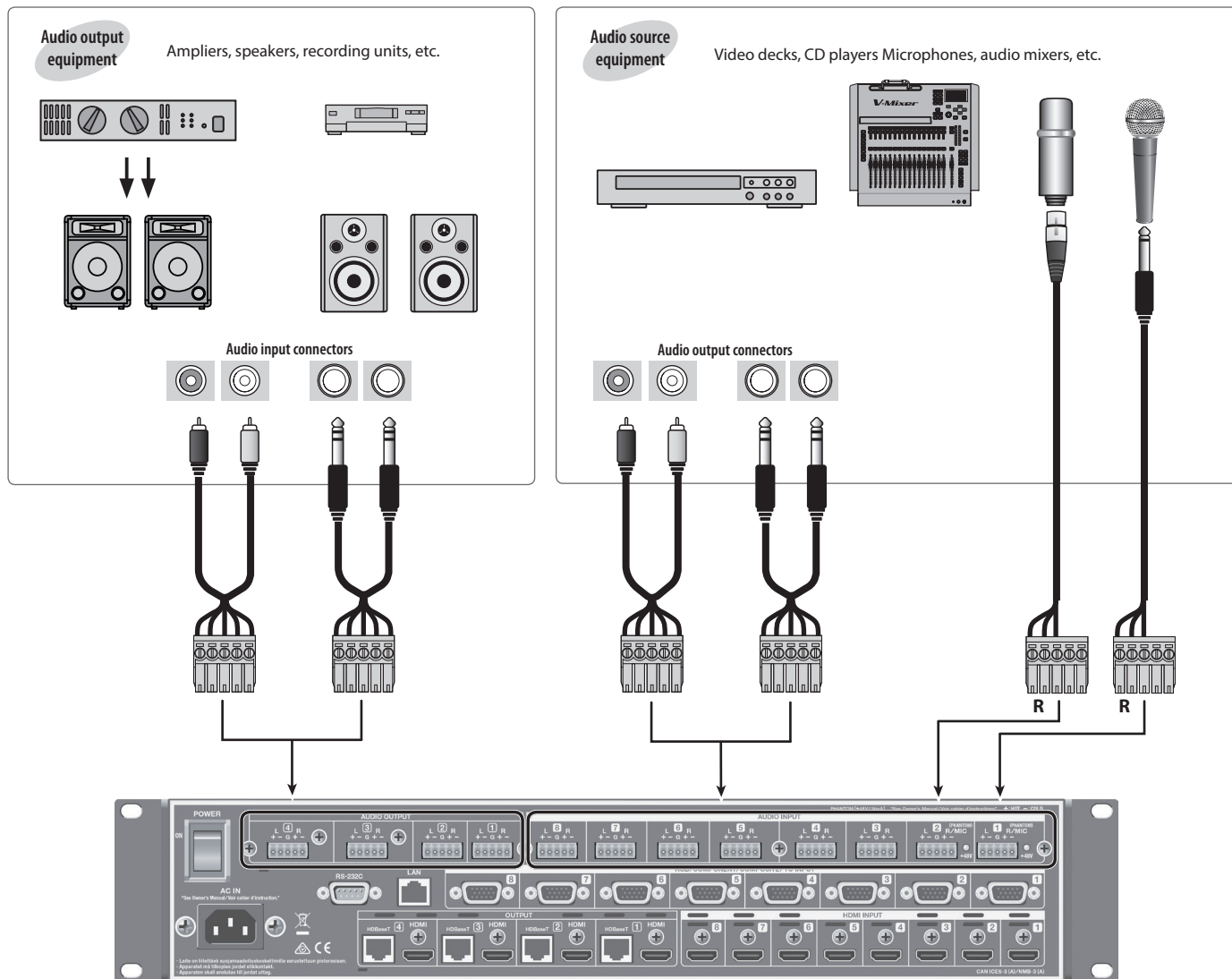

XS-84H

- \* Connect microphones to the R channel of AUDIO INPUT connector 1 or 2. For information on how to perform wiring, refer to "AUDIO INPUT/OUTPUT connectors" (p. 33).
- \* AUDIO INPUT and OUTPUT connectors are wired as shown in the figure below. Make connections after first checking the wiring diagrams of other equipment you intend to connect.

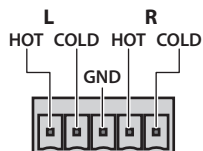

- For information on how to attach cables to the included Euroblock plugs, refer to "Connecting Cables to the Euroblock Plugs" (p. 13).
- For information on how to perform wiring, refer to "AUDIO INPUT/OUTPUT connectors" (p. 33).
- \* Acoustic feedback could be produced depending on the location of microphones relative to speakers. This can be remedied by:
  - Changing the orientation of the microphone(s).
  - Relocating microphone(s) at a greater distance from speakers.
  - Lowering volume levels

## Using Phantom Power

AUDIO INPUT connectors 1 and 2 (R channel only) can supply phantom power (+48 V).

When using a condenser microphone that requires phantom power, turn on phantom power.

[MENU] button → "AUDIO INPUT" → "ANALOG-1" or "ANALOG-2" → set "PHANTOM POWER" to "ON."

The phantom power indicator next to the connector lights up when phantom power is turned on.

### NOTE

Always turn the phantom power off when connecting any device other than condenser microphones that require phantom power. You risk causing damage if you mistakenly supply phantom power to dynamic microphones, audio playback devices, or other devices that don't require such power. Be sure to check the specifications of any microphone you intend to use by referring to the manual that came with it. (This instrument's phantom power: 48 V DC, 14 mA Max)

# Connecting the Power Cord

### NOTE

Be sure to use the included power cord for connecting the power supply.

1. Connect the included power cord to the AC IN connector on the rear panel.

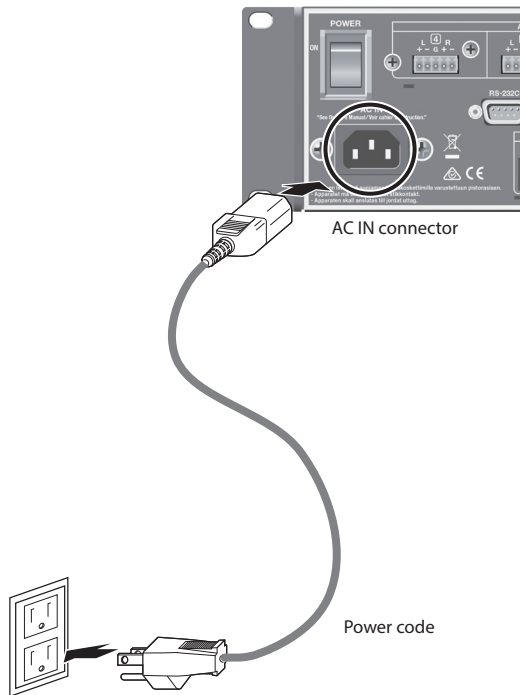

\* The shape of the power cord's plug varies depending on the country.

# Basic Operation

## Turning the Power On and Off

Once everything is properly connected (p. 14), be sure to follow the procedure below to turn on their power. If you turn on equipment in the wrong order, you risk causing malfunction or equipment failure.

- \* Before turning the unit on/off, always be sure to turn the volume down. Even with the volume turned down, you might hear some sound when switching the unit on/off. However, this is normal and does not indicate a malfunction.
- \* Importing still images (p. 21) might result in longer startup times, depending on the image size and the number saved.

### Turning the Power On

1. Make sure all devices are turned off.
2. Turn on the [POWER] (main power) switch on the unit's rear panel.

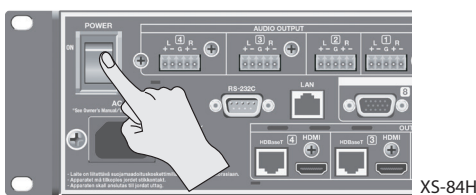

The power indicator on the front panel lights up in red, and the unit goes into standby.

3. Press the power button on the unit's front panel to turn on the power.

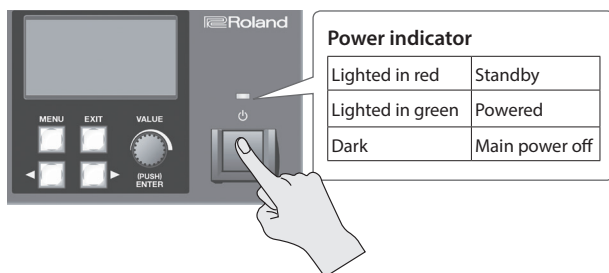

The power comes on and the color of the lighted power indicator changes to green.

- \* This unit is equipped with a protection circuit. A brief interval (a few seconds) after turning the unit on is required before it will operate normally.

4. Turn on the power to the source devices.

Turn on the power to source equipment connected to input connectors on the unit.

5. Turn on the power to the output devices.

Turn on the power to projectors or other devices connected to output connectors on the unit.

### Turning the Power Off

1. Turn off the power first to output equipment, and then to source equipment.
2. If the unit's power is on, press the power button once more.  
The color of the lighted power indicator changes from green to red, and the unit goes into standby.
3. Turn off the [POWER] (main power) switch on the rear panel.

The power indicator goes dark and the power is turned off.

- \* If you need to turn off the power completely, first turn off the unit, then unplug the power cord from the power outlet. Refer to "To completely turn off power to the unit, pull out the plug from the outlet" (p. 5).

## Using the Menu

This explains how to display menus and make various settings

### MEMO

For more information about the menus, download and refer to the Reference Manual (PDF) for the unit from the following Roland website.

<http://proav.roland.com>

1. Press the [MENU] button to display the menu.

The menu categories are displayed.

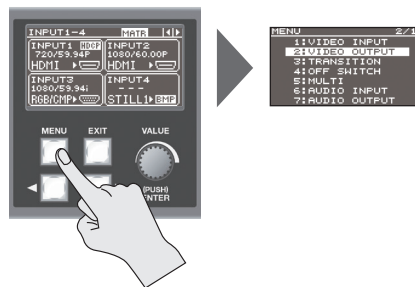

2. Turn the [VALUE] dial to select a category, then press the [VALUE] dial to confirm the selection.

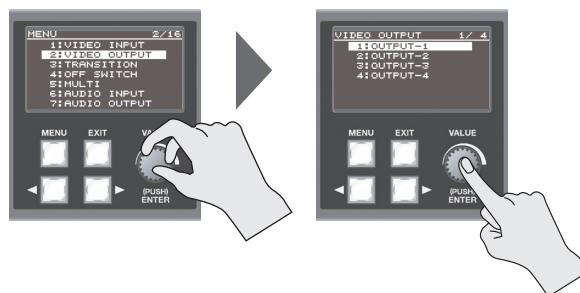

The menu items for the selected category are displayed.

3. Turn the [VALUE] dial to select a menu item, then press the [VALUE] dial to confirm the selection.
  - If the menu item is located at a deeper level, repeat step 3.
4. Turn the [VALUE] dial to change the setting value.
  - If there is more than one setting location, use the cursor buttons to move the cursor, then change the setting.
  - You can use the cursor buttons to jump to the setting screen for a different channel or the like, without having to go back up one level.
  - You can change the setting value in larger steps by holding down the [VALUE] dial as you turn it.
5. Press the [MENU] button to quit the menu.  
Pressing the [EXIT] button once returns you to the previous screen.

### MEMO

You can return the menu item you're setting to its factory-default value by holding down the [VALUE] knob and pressing the [EXIT] button.

## Changing the View on the Display

The unit's top screen has five types of view modes. You use the cursor buttons to change the view mode.

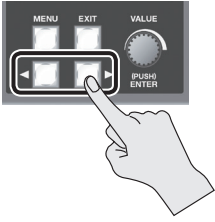

### Input/output status screen

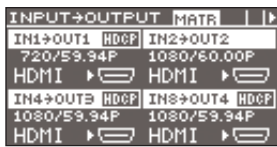

This displays information about the currently selected video input and output channels.

XS-84H



### Input status screen 1/2



This displays information about video input channels 1 through 4.



### Input status screen 2/2

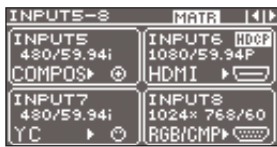

This displays information about video input channels 5 through 8.



### Output status screen



This displays information about the video output channels.

XS-84H



### Audio volume control screen

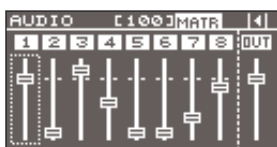

This displays audio faders for eight audio input channels and one output channel.

You operate the audio faders to adjust the volume levels for audio input and output (p. 25, p. 26).

\* You can change the audio input channels and output channel assigned to the audio faders as required. For details, refer to "Changing Audio Fader Assignments" in the column at right.

### MEMO

- You can adjust the brightness of the display. Use the [MENU] button → "SYSTEM" → "LCD BACKLIGHT" to adjust.
- You can set the view mode of the display at startup by using the [MENU] button → "SYSTEM" → "TOP DISPLAY."

## Changing Audio Fader Assignments

At the audio volume control screen, you can display audio faders for eight audio input channels and one audio output channel.

You can change the audio input channels and output channel assigned to the audio faders as required.

### Assigning an Audio Input Channel

- Use the [MENU] button → "AUDIO CONTROL" → "FADER 1" through "FADER 8" to select the audio input channel to assign to the respective audio fader.

You can choose from among "HDMI INPUT 1" through "HDMI INPUT 8" and "ANALOG INPUT 1" through "ANALOG INPUT 8."

- Press the [MENU] button to quit the menu.

### Assigning an Audio Output Channel

- Use the [MENU] button → "AUDIO CONTROL" → "OUTPUT FADER" to select the audio output channel to assign to the audio fader.

You can choose from among "OUTPUT 1" through "OUTPUT 4" (Note: This varies according to the model.), or "ALL." Selecting "ALL" makes it possible to adjust the audio on all audio output channels simultaneously.

- Press the [MENU] button to quit the menu.



# Video Operations

## Setting the Video Signal for Each Video Input Channel

This sets the type of incoming video signal for each individual video input channel.

### NOTE

No video is output if the type setting for the input video signal is incorrect.

### MEMO

You can assign a still image imported from a USB flash drive to a video input channel and output it in the same way as video. For details, refer to "Outputting an Imported Still Image" (p. 21).

1. Use the [MENU] button → "VIDEO INPUT" → "INPUT-1" through "INPUT-8" → "INPUT SELECT" to make your selection.
2. Turn the [VALUE] dial to select the video signal.
  - If you want to output a still image imported into the unit, choose "STILL1" through "STILL4" (p. 21).
  - Selecting "SHARE" enables sharing of a video source on the video input channels. For details, refer to the column below, "Sharing a Video Source (SHARE)."
3. Press the [MENU] button to quit the menu.

### MEMO

When video is input, the INPUT STATUS indicator lights up.

Lighted in blue	HDMI signal
Lighted in red	Analog video signal
Lighted up in white	Still picture
Dark	No input signal

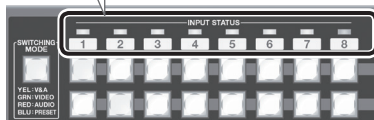

## Sharing a Video Source (SHARE)

You can share a video source on the video input channels. Sharing a video source assigns a single video source to two or more input channels.

The video source you can share on video input channels is the source on the previous channel. For example, to share the video on channel 1 on channels 2 through 8, set "INPUT SELECT" for channels 2 to 8 to "SHARE."

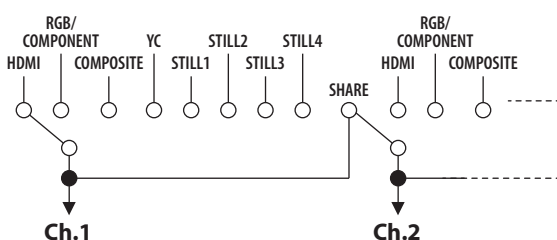

\* Audio sources cannot be shared.

## Changing Cross Points

This changes the cross points for video or audio.

- \* This unit provides a variety of output modes for video output. The explanation in this section describes the procedure for changing the cross point when the output mode is set to "MATRIX."
- For information on how to set the output mode, refer to "Switching the Video Output Mode" (p. 22).

1. Use the [MENU] button → "TRANSITION" → "TIME" to set the length of the video transition (0.0 to 10.0 sec).  
When you want an instant video transition, set the value to "0.0 sec."  
\* The "TIME" setting is shared with the fade time (p. 24).
2. Press the [SWITCHING MODE] button to change the operation mode of the cross-point selection buttons.

### Indicators and operation modes

Lighted in yellow	Video and audio interlink mode
Lighted in green	Video independent mode
Lighted in red	Audio independent mode
Lighted in blue	Preset mode

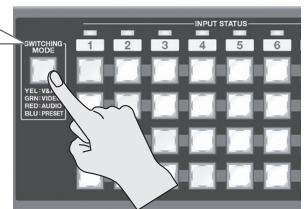

XS-84H

Successive presses of the [SWITCHING MODE] button cycle through the modes in this sequence: video and audio interlink mode → video independent mode → audio independent mode → preset mode.

### NOTE

When the [SWITCHING MODE] button is lighted up in blue (preset mode), the cross-point selection buttons function as memory-number selection buttons (p. 27).

3. Press a cross-point selection button.

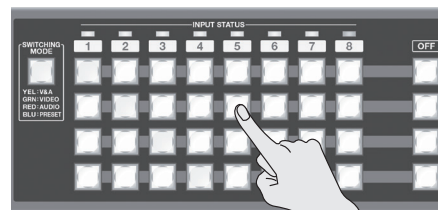

XS-84H

Each button's horizontal direction is the input channel and vertical direction is the output channel. The cross point of the audio or video channel is switched according to the operation mode you selected in step 2.

The current selection of audio or video channel is indicated by the color of the lighted button.

- Lighted in yellow: Video channel and audio channel
- Lighted in green: Video channel only
- Lighted in red: Audio channel only

### MEMO

You can change the fade color used during the video transition. Use the [MENU] button → "OFF SWITCH" → "RED," "GREEN," or "BLUE" to adjust the color. The setting for fade color is shared with fades (p. 24).

## Inputting/Outputting Copyright-protected (HDCP) Video

This unit lets you enable and disable HDCP (digital content protection) individually for copyright-protected (HDCP) video that is input and output. By default, input and output of HDCP-protected video are enabled. To enable or disable HDCP input and output, use the procedure described below to described below to change the setting.

### Input

1. Use the [MENU] button → “VIDEO INPUT” → “INPUT-1” through “INPUT-8” → “HDCP INPUT ENABLE” to make the setting.

Setting value	Description
ENABLE	Copyright-protected (HDCP) video can be input.
DISABLE	Copyright-protected (HDCP) video cannot be input.

2. Press the [MENU] button to quit the menu.

**NOTE**

When inputting or outputting video on which no copyright protection (HDCP) is applied, the effects of HDCP on other channels might result in no audio output.

For details, refer to “Important Notes When Working with Copyright-protected (HDCP) Video” in the Reference Manual (PDF).

### Output

1. Use the [MENU] button → “VIDEO OUTPUT” → “OUTPUT-1” through “OUTPUT-4” (Note: This varies according to the model.) → “HDCP OUTPUT ENABLE” to make the setting.

Setting value	Description
ENABLE	Video is output with copyright protection (HDCP) applied. HDCP is applied even to output video that is not copyright-protected (HDCP).
DISABLE	Video is output with no copyright protection (HDCP) applied. * Copyright-protected (HDCP) video cannot be output with no HDCP applied. When the setting is at “DISABLE,” a black video image is output.

2. Press the [MENU] button to quit the menu.

### Checking HDCP-compatible Equipment

When the setting for HDCP-applied input or output is at “ENABLE,” you can use the output status view or input status view on the display to check the state of HDCP compatibility of connected equipment.

#### Input status screen

The HDCP icon is displayed when copyright-protected (HDCP) video is input.



#### Output status screen

The HDCP icon is displayed when HDCP-compatible equipment is connected.

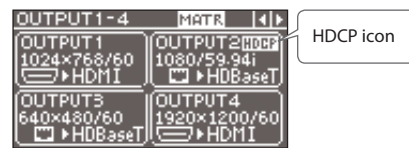

XS-84H

## Switching Between HDMI Output and HDBaseT Output

By factory default, the selection of HDMI output and HDBaseT output is set at "AUTO" (the setting for automatic detection on connection). When devices are connected to both the HDMI OUTPUT connector and the HDBaseT OUTPUT connector, HDMI output takes precedence.

When you want to output video via a specified OUTPUT connector, change the setting.

### NOTE

Simultaneously outputting video from both the HDMI OUTPUT connector and the HDBaseT OUTPUT connector on the same channel is not possible.

1. Use the [MENU] button → "VIDEO OUTPUT" → "OUTPUT-1" through "OUTPUT-4" (Note: This varies according to the model.) → "OUTPUT SELECT" to make the setting.

Setting value	Description
AUTO	The connector where the connection is made is automatically detected and video is output. When devices are connected to both the HDMI OUTPUT connector and the HDBaseT OUTPUT connector, HDMI output takes precedence.
HDMI	Video is output only from the HDMI OUTPUT connector.
HDBaseT	Video is output only from the HDBaseT OUTPUT connector.

2. Press the [MENU] button to quit the menu.

## Outputting an Imported Still Image

This assigns a still image imported from a USB flash drive to a video input channel and outputs it in the same way as video.

### Supported Still-image Formats and Resolutions

Still-image file formats that can be imported are as follows.

Format	Bitmap (.bmp), 24-bit, uncompressed
Resolution	Maximum 1,920 x 1,200 pixels

### NOTE

Still images cannot be scaled. Provide a still image whose resolution matches the final format.

### Importing a Still Image

This imports into the unit a still image saved on a USB flash drive. You can save four still images in the unit.

\* When you're using a USB flash drive for the first time, be sure to format it on the unit (p. 28).

1. Save the still image in the root directory of the USB flash drive.  
Give the still image a file name composed of no more than eight alphanumeric characters, and be sure to append a ".bmp" file extension.
2. Connect the USB flash drive containing the saved still image to the USB MEMORY connector.
3. Select the [MENU] button → "USB MEMORY" → "LOAD STILL IMAGE" → the destination for saving the still image (1 through 4), then press the [VALUE] dial.  
The "LOAD STILL IMAGE" popup appears. The names of the files on the USB flash drive are displayed in the popup.
4. Select the still image file you want to import, then press the [VALUE] dial.
5. Check the message and press the [VALUE] dial.  
(If you want to quit, press the [EXIT] button.)  
The still image is imported into the unit
6. Press the [MENU] button to quit the menu.

### NOTE

Importing still images might result in longer startup times, depending on the image size and the number saved.

### Outputting a Still Image

This outputs the still image imported into the unit.

1. Assign the still image to a video input channel.  
Follow the procedure in "Setting the Video Signal for Each Video Input Channel" (p. 19), and at step 2, select "STILL1" through "STILL4."
2. Press the cross-point selection button for the video input channel where "STILL1" through "STILL4" is assigned (p. 19).  
The still image is output.

# Switching the Video Output Mode

This unit provides a variety of output modes for video output. Selecting an output mode recalls preset values for video output.

- \* You can change "VIDEO OUTPUT" settings after recalling the preset values for video output. Note, however, that depending on the "MODE" setting, some individual menu items might be unchangeable.
- For details, refer to "VIDEO OUTPUT" under "Menu List" in the Reference Manual (PDF).

## 1. Select the [MENU] button → "MODE" → the output mode.

In this section, output images are described using A through H for the input video and 1 through 4 for the output video, as shown in the figure at right.

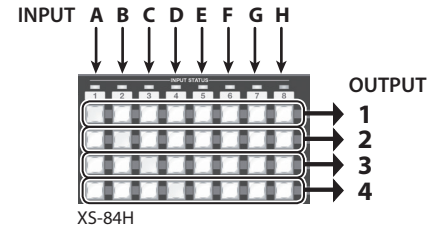

Setting value	Description	Output image				Interlinked buttons				Button illumination pattern			
		OUTPUT 1	OUTPUT 2	OUTPUT 3 XS-83H and XS-84H only	OUTPUT 4 XS-84H only	OUTPUT							
						1	2	3	4				
MATRIX	This outputs the video input channels selected using the cross-point selection buttons (p. 19).	A	B	C	D					[Grid of 16 buttons]			
MULTI-2 (*1)	<p>This combines video pictures into composite output. The layer positions are fixed and cannot be changed.</p>	A	A	C	D					[Grid of 16 buttons]			
MULTI-3 (*1)		A	A	C	D					[Grid of 16 buttons]			
MULTI-4 (*1)		A	A	C	D					[Grid of 16 buttons]			
SPAN-2	This displays a single video picture across multiple screens.	A	A	C	D	✓	✓			[Grid of 16 buttons]			
SPAN-3 (*2)		A	A	C	D	✓	✓	✓		[Grid of 16 buttons]			
SPAN-4 (*3)		A	A	C	D	✓	✓	✓	✓	[Grid of 16 buttons]			
ROTATION-L1	This outputs the picture rotated 90 degrees counterclockwise.	A	A	C	D	✓	✓	✓	✓	[Grid of 16 buttons]			
ROTATION-L2		A	A	C	D	✓	✓	✓	✓	[Grid of 16 buttons]			
ROTATION-L3 (*2)		A	A	C	D	✓	✓	✓	✓	[Grid of 16 buttons]			
ROTATION-L4 (*3)		A	A	C	D	✓	✓	✓	✓	[Grid of 16 buttons]			

Setting value	Description	Output image				Interlinked buttons				Button illumination pattern
		OUTPUT 1	OUTPUT 2	OUTPUT 3 XS-83H and XS-84H only	OUTPUT 4 XS-84H only	OUTPUT				
						1	2	3	4	
ROTATION-R1	This outputs the picture rotated 90 degrees clockwise.					✓	✓	✓	✓	
ROTATION-R2						✓	✓	✓	✓	
ROTATION-R3 (*2)						✓	✓	✓	✓	
ROTATION-R4 (*3)						✓	✓	✓	✓	
4K-1 (*3)	Pressing the cross-point selection buttons switches video output channels 1 through 4 simultaneously. Video input channel 1 through 4 and 5 through 8 are respectively grouped together as a set, and regardless of which cross-point selection button is pressed, the cross-point selection buttons are automatically selected as shown in the figure at right.	OUTPUT 1		OUTPUT 2		✓	✓	✓	✓	
		OUTPUT 3		OUTPUT 4		✓	✓	✓	✓	
4K-2 (*3)	<ul style="list-style-type: none"> <li>Video input channels 1 – 4 Operation is the same as for 4K-1.</li> <li>Video input channels 5 – 8 The single video picture selected using the cross-point selection buttons is displayed across four screens.</li> </ul>	OUTPUT 1		OUTPUT 2		✓	✓	✓	✓	
		OUTPUT 3		OUTPUT 4		✓	✓	✓	✓	

- (\*1) • The same video and audio are output on the channels used for composited output.  
 • **XS-82H/XS-83H:** Video in windows that cannot be specified using cross-point selection buttons can be selected by using the MENU button → "MULTI" → "SOURCE CH."  
 • Size and other settings for windows can be adjusted by using the MENU button → "MULTI."

(\*2) XS-83H and XS-84H only

(\*3) XS-84H only

## 2. Press the [MENU] button to quit the menu.

### MEMO

You can output video combined with a vertically or horizontally flipped picture.

Vertical flipping: [MENU] button → "VIDEO INPUT" → "INPUT-1" through "INPUT-8" → "FLIP VERTICAL," and set this to "ON."

Horizontal flipping: [MENU] button → "VIDEO OUTPUT" → "OUTPUT-1" through "OUTPUT-4" (Note: This varies according to the model.) → "FLIP HORIZONTAL," and set this to "ON."

- You can determine the current output mode by checking the output mode icon on the top screen.

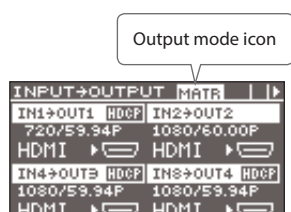

# Applying a Fade to Output Video

This applies a fade to output video.

### 1. Use the [MENU] button → “TRANSITION” → “TIME” to set the fade time (0.0 to 10.0 sec).

If you want to change to a monochrome picture instantly, set “0.0 sec” as the value.

\* The “TIME” setting is shared with the length of time for which video transitions (p. 19) are applied.

### 2. Press the [OFF] button for the video output channel where you want the fade-out to occur.

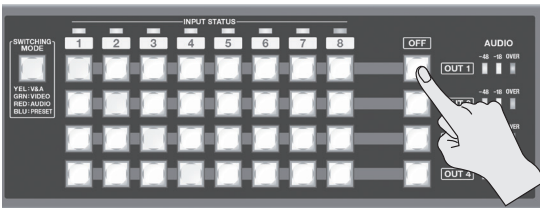

XS-84H

The video fades out over the time interval you set in step 1. The [OFF] button flashes while the fade takes place. When the fade-out has been completed, the [OFF] button stops flashing and stays lighted.

### 3. To perform a fade-in, press the [OFF] button a second time.

The [OFF] button flashes and video output starts. When the fade-in has been completed, the [OFF] button goes dark.

#### MEMO

- You can change the fade color. Use the [MENU] button → “OFF SWITCH” → “RED,” “GREEN,” or “BLUE” to adjust the color. The setting for fade color is shared with video transitions (p. 19).
- By default, the system is set up so that audio also fades out or in as a video fade-out or fade-in occurs.

To decouple the audio from this, select the [MENU] button → “OFF SWITCH” → “AUDIO FOLLOW,” and set it to “OFF.”

# Audio Operations

## Adjusting Microphone Gain

This adjusts the input sensitivity of microphones connected to the R channels of AUDIO INPUT connectors 1 and 2.

### MEMO

- Input sensitivity can be adjusted for only the R channel of AUDIO INPUT connectors 1 and 2. For microphones, make the connection to the R channel of AUDIO INPUT connector 1 or 2.
- By default, AUDIO INPUT connectors 1 and 2 are configured for stereo input. When connecting a microphone, select the [MENU] button → "AUDIO INPUT" → "ANALOG-1" or "ANALOG-2" → "MONO INPUT," and set it to "ON" (monaural input).

### 1. Set the volume level of the microphone connected to AUDIO INPUT connector 1 or 2 to "100 (0 dB)."

You can use either of the following two methods to adjust the volume level.

- Change the display to the audio volume control screen, then raise the channel fader to the "100" (0 dB) position.  
For more information on how to do this, refer to "Using Audio Faders to Adjust the Volume Level" in the column at right.

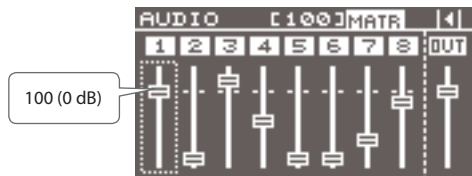

- Select the [MENU] button → "AUDIO INPUT 1" → "ANALOG-1" or "ANALOG-2" → "INPUT LEVEL," and set this to "100 (0 dB)."

### 2. Select the [MENU] button → "AUDIO INPUT" → "ANALOG-1" or "ANALOG-2" → "INPUT GAIN."

### 3. Turn the [VALUE] dial all the way counterclockwise to lower the input sensitivity.

### 4. Slowly turn the [VALUE] dial clockwise to adjust the input sensitivity.

While inputting actual audio, turn the [VALUE] dial to increase and adjust the input sensitivity.

### 5. Press the [MENU] button to quit the menu.

## Adjusting the Volume Balance of Input Audio

This adjusts the volume balance of the audio input to the unit.

### NOTE

Even when an HDMI connection is used, no HDMI audio is input unless "HDMI" has been selected in the settings for the video input channel (p. 19).

## Using Audio Faders to Adjust the Volume Level

You operate the audio faders shown on the display to adjust the volume levels.

1. Before you start, make the settings for the audio input channels assigned to the audio faders on the display (p. 18).
2. Use the cursor buttons to switch the display to the screen for audio volume control (p. 18).
3. Raise or lower the audio faders to adjust the volume balance for each channel.

Turn the [VALUE] dial to select the audio fader to operate (1 through 8), then press the [VALUE] dial to apply the selection.

Turn the [VALUE] dial to adjust the volume level of the input channel. Pressing the [VALUE] dial once more lets you select the audio fader to operate.

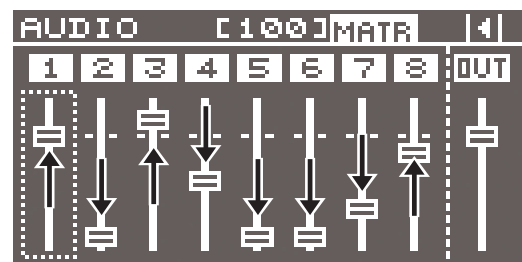

## Using the Menus to Adjust the Volume Level

1. Select the [MENU] button → "AUDIO INPUT" → "HDMI-1" through "HDMI-8" or "ANALOG-1" through "ANALOG-8" → "INPUT LEVEL," then adjust the volume level.
2. Press the [MENU] button to quit the menu.



## Adjusting the Volume Level of Output Audio

This adjusts the volume level of output audio.

### Checking the Volume Level

1. See the level meter to check the volume level of output audio.

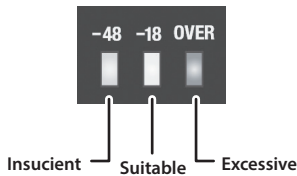

If "OVER" lights up, the volume level is too high.

A level where the "-18" indicator lights up when peak-volume audio is input is appropriate.

**NOTE**

If the volume level of speaker output is not appropriate even after adjusting so that "-18" lights up only at peak volume, adjust the volume levels of the speakers and amplifiers. Using the output channel faders to make adjustments might result in distortion or reduced sound quality. Use the audio faders to adjust the volume level.

### Using Audio Faders to Adjust the Volume Level

1. Before you start, make the settings for the audio output channels assigned to the audio faders on the display (p. 18).
2. Use the cursor buttons to switch the display to the screen for audio volume control (p. 18).
3. Raise or lower the audio faders to adjust the volume levels.

Turn the [VALUE] dial to select the output audio fader, then press the [VALUE] dial to apply the selection. Turn the [VALUE] dial to adjust the output-channel volume level.

Pressing the [VALUE] dial once more lets you select the audio fader to operate.

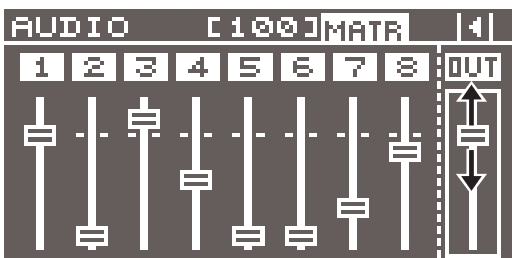

### Using the Menus to Adjust the Volume Level

1. Select the [MENU] button → "AUDIO OUTPUT" → "OUTPUT-1" to "OUTPUT-4" (Note: This varies according to the model.) → "OUTPUT LEVEL," then adjust the volume level.
2. Press the [MENU] button to quit the menu.

# Other Features

## Saving/Recalling Settings (Presets)

You can internally save current cross points, audio/video settings, and other values as presets and recall them for use when needed. The unit can save 32 presets.

### Saving Settings

1. Select the [MENU] button → “PRESET MEMORY” → “SAVE SETTING” → a save-destination preset number (1 to 32), then press the [VALUE] button.
2. Check the message and press the [VALUE] dial. (If you want to quit, press the [EXIT] button.)  
The current settings are saved as a preset.
3. Press the [MENU] button to quit the menu.

#### MEMO

The settings for the categories listed below are not saved in each individual preset. Only a single set is saved in the unit.

- EDID ((DATA1–DATA8)
- RS-232C
- LAN
- WIRELESS LAN
- USB MEMORY
- SYSTEM

After settings for menu items have been made, the new values are saved in the unit’s internal memory when you exit the menu.

### Saving Settings on a USB Flash Drive

You can save all presets and system settings grouped together into a single file on a USB flash drive inserted into the USB port.

- \* When you’re using a USB flash drive for the first time, be sure to format it on the unit (p. 28).

#### Saving Settings

To execute this, select the [MENU] button → “USB MEMORY” → “SAVE PRESET” or “SAVE AS PRESET.”

#### Importing Settings

To execute this, select the [MENU] button → “USB MEMORY” → “LOAD PRESET” → the file you want to import.

### Recalling Settings

This calls up a saved preset.

When recalling a preset, by pre-specifying the setting values to call up, you can recall just some settings without having to call up all stored settings.

#### NOTE

If changes are made in the video input connectors or the output format in the preset before and after recalling, output video might become corrupted.

1. Specify the setting values in the preset that you want to recall.

Select the [MENU] button → “PRESET MEMORY” → “RECALL SAFE” → “ON,” then press the [VALUE] dial.

The “RECALL SAFE” popup appears. Specify whether the settings for the following items are individually recalled (OFF) or not individually recalled (ON).

Setting items	Description
VIDEO INPUT	Video input settings, input EDID assignment settings
VIDEO OUTPUT	Video output settings
OUT RESOLUTION	Output resolution setting
TRANSITION	Video transition time/fade time setting
OFF SWITCH	[OFF] switch settings
MULTI	Multi-view settings
AUDIO INPUT	Audio input settings
AUDIO OUTPUT	Audio output settings
AUDIO CONTROL	Fader assignment settings at the audio volume control screen
MODE	Output mode settings
CROSSPOINT	Cross-point selection button settings

2. Press the [SWITCHING MODE] button several times to make it light up in blue (preset mode).

Preset numbers are assigned to the cross-point selection buttons as shown below.

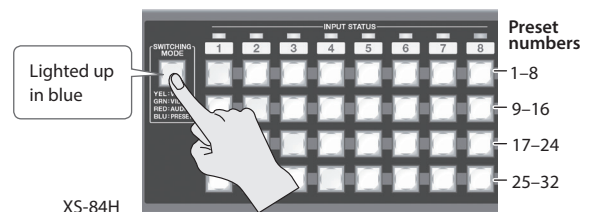

- \* The cross-point selection buttons for numbers where presets are saved light up in blue.

- \* **XS-82H/XS-83H:** If a preset number has no corresponding cross-point selection button, use the [MENU] button → “PRESET MEMORY” → “LOAD SETTINGS” to specify the preset number and recall the settings.

3. Press the cross-point selection button for the preset number whose setting you want to recall.

The settings are recalled. The currently selected cross-point selection button lights up in light blue.

#### MEMO

You can also recall a specified preset at startup. Use the [MENU] button → “SYSTEM” → “STARTUP” to specify the preset number you want to recall.

## Formatting USB Flash Drives

When you're using a USB flash drive for the first time, it must first be formatted on the unit.

**NOTE**

- USB flash drives not formatted on the unit cannot be recognized.
- Performing formatting causes all data already saved on the USB flash drive to be deleted. If the flash drive contains necessary data, back it up onto a computer or elsewhere before formatting the drive.

## Making the Connection

Carefully insert the USB flash drives all the way in—until it is firmly in place.

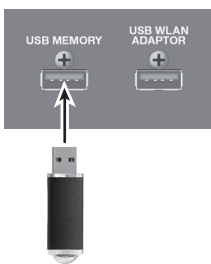

**NOTE**

- Never turn off the power or disconnect the USB flash drives while the screen indicates "Please wait..."
- After connecting the USB flash drive, a short wait may be required until reading and writing data become possible.

## Performing Formatting

1. Select the **[MENU]** button → "USB MEMORY" → "FORMAT," then press the **[VALUE]** dial.
2. Check the message and press the **[VALUE]** dial. (If you want to quit, press the **[EXIT]** button.)  
Formatting of the USB flash drive is carried out.
3. Press the **[MENU]** button to quit the menu.

## Returning Settings to the Factory-default State (Factory Reset)

This returns the values of the unit's setting to their factory defaults. If operation that differs from what is described in the owner's manual occurs even when the steps described are followed correctly, try performing a factory reset.

**NOTE**

Performing a factory reset causes all settings made, values saved in presets (p. 27), and any imported still image (p. 21) to be lost.

1. Select the **[MENU]** button → "SYSTEM" → "FACTORY RESET," then press the **[VALUE]** dial.
2. Check the message and press the **[VALUE]** button. (If you want to quit, press the **[EXIT]** button.)  
A factory reset is executed.
3. Press the **[MENU]** button to quit the menu.

## Remote Control from an External Device

**The XS-80H Remote application for the iPad is compatible with version 1.1 and later of the system program for this unit.** You can check the version of the system program by selecting the **[MENU]** button → "SYSTEM" → "VERSION."

Inserting a wireless USB adaptor (sold separately) into the USB WIRELESS ADAPTOR connector lets you operate the unit remotely by using the XS-80H Remote application for the iPad.

\* For the wireless USB adaptor, use the ONKYO UWF-1 or Roland WNA1100-RL.

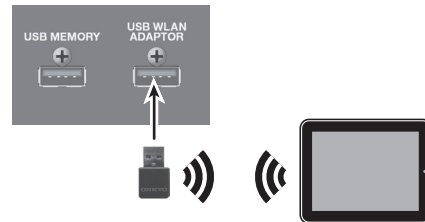

You can use the RS-232C connector or LAN port to operate the unit remotely from a computer or other external device.

You can also use the XS-80H Remote application to operate the unit remotely via a Wi-Fi router connected to the LAN port.

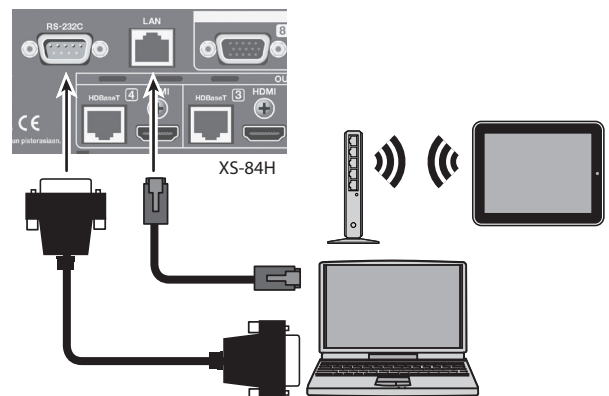

For detailed information about remote control, download and refer to the Reference Manual (PDF) from the following Roland website.  
<http://proav.roland.com>

# Appendices

## Troubleshooting

Problem	Items to check	Action	Page
<b>Problems with Video</b>			
<b>No picture is input.</b>	Is the type of incoming video signal set correctly for each video input channel?	Set the video-signal type for each individual video input channel. Video might not be displayed, or might be displayed improperly, if the type of video signal is not set correctly.	p. 19
	Is copyright-protected (HDCP) video being input?	When inputting copyright-protected (HDCP) video signals, set "HDCP INPUT ENABLE" to "ENABLE."	p. 20
<b>No picture is output.</b>	Is the output resolution set correctly?	Set the output resolution for each individual output channel. Use "VIDEO OUTPUT" → "OUTPUT-1" through "OUTPUT-4" → "RESOLUTION" to change the setting.	—
	Is copyright-protected (HDCP) video being output?	When outputting copyright-protected (HDCP) video signals, set "HDCP OUTPUT ENABLE" to "ENABLE."	p. 20
		Check whether an HDCP-compatible monitor is being used.	—
		When all of the following conditions obtain, the multi-view output channel is a black picture. <ul style="list-style-type: none"> <li>The video output mode is at a setting from "MULTI-2" to "MULTI-4."</li> <li>"HDCP OUTPUT ENABLE" for the output channel is set to "DISABLE."</li> <li>Copyright-protected (HDCP) video is being input in one of the multi-view windows.</li> </ul>	—
	Is the correct OUTPUT connector (HDMI or HDBaseT output connector) selected?	Simultaneously outputting video from both the HDMI output connector and the HDBaseT output connector on the same channel is not possible. By factory default, the selection of HDMI output and HDBaseT output is set at "AUTO" (the setting for automatic detection on connection). When devices are connected to both the HDMI OUTPUT connector and the HDBaseT OUTPUT connector, HDMI output takes precedence. When you want to output video from a specified OUTPUT connector, change the "OUTPUT SELECT" setting.	p. 21
<b>Colors are incorrect.</b>	Does the color space of the video being input or output match the color space for the processing being done by the unit?	Change the "COLOR SPACE" settings for "VIDEO INPUT" and "VIDEO OUTPUT."	—
		Depending on the device, the color space might be interlinked with the selection of DVI or HDMI or the selected format. In such happens, changing the color space on the input or output device might bring about improvement for the problem.	
<b>HDMI output shown on a display has its periphery cut off.</b>	Are the display settings compatible?	In the case of HDMI signals, automatic overscan occurs on some displays. Change the display's settings.	—
<b>Problems with Audio</b>			
<b>No audio is output. The audio volume is too low.</b>	Is the volume turned down on the connected amplifiers or speakers?	Adjust to an appropriate volume level.	—
	Is the volume turned down on the unit?	Adjust the volume of input and output audio to appropriate levels.	p. 25 p. 26
	Are copyright-protected (HDCP) signals being sent in a mixed state to a video output connector for which "HDCP OUTPUT ENABLE" is set to "DISABLE"?	When inputting or outputting video on which no copyright protection (HDCP) is applied, the effects of HDCP on other channels might result in no audio output. For details, refer to "Important Notes When Working with Copyright-protected (HDCP) Video" in the Reference Manual (PDF). <a href="http://proav.roland.com">http://proav.roland.com</a>	—
	Is gain (input sensitivity) turned down on audio channels 1 and 2?	When the input sensitivity is turned down on audio channels 1 and 2, no audio is output even when the volume is raised. Go to "AUDIO INPUT" and use "INPUT GAIN" to adjust the input sensitivity.	p. 25
	Is a condenser microphone connected?	When connecting a condenser microphone or other device that requires phantom power, go to "AUDIO INPUT" and set "PHANTOM POWER" to "ON"	p. 15
<b>Other Problems</b>			
<b>A USB flash drive cannot be read.</b>	Was the USB flash drive formatted on the unit?	When you're using a USB flash drive for the first time, be sure to format it on the unit.	p. 28
	Was a non-Roland USB flash drive used?	Operation of non-Roland USB flash drives cannot be assured. Operation has been tested for commonly available USB flash drives, but operation with all USB flash drives is not assured. Depending on the manufacturer and type of the USB flash drive, correct operation may not be possible.	—
<b>The unit is extremely hot.</b>	Has the cooling fan stopped?	Immediately stop use and contact a Roland Service Center.	—

# Block Diagram

## Video Block

HDMI/DVI Inputs x 8

Analog Video Inputs x 8

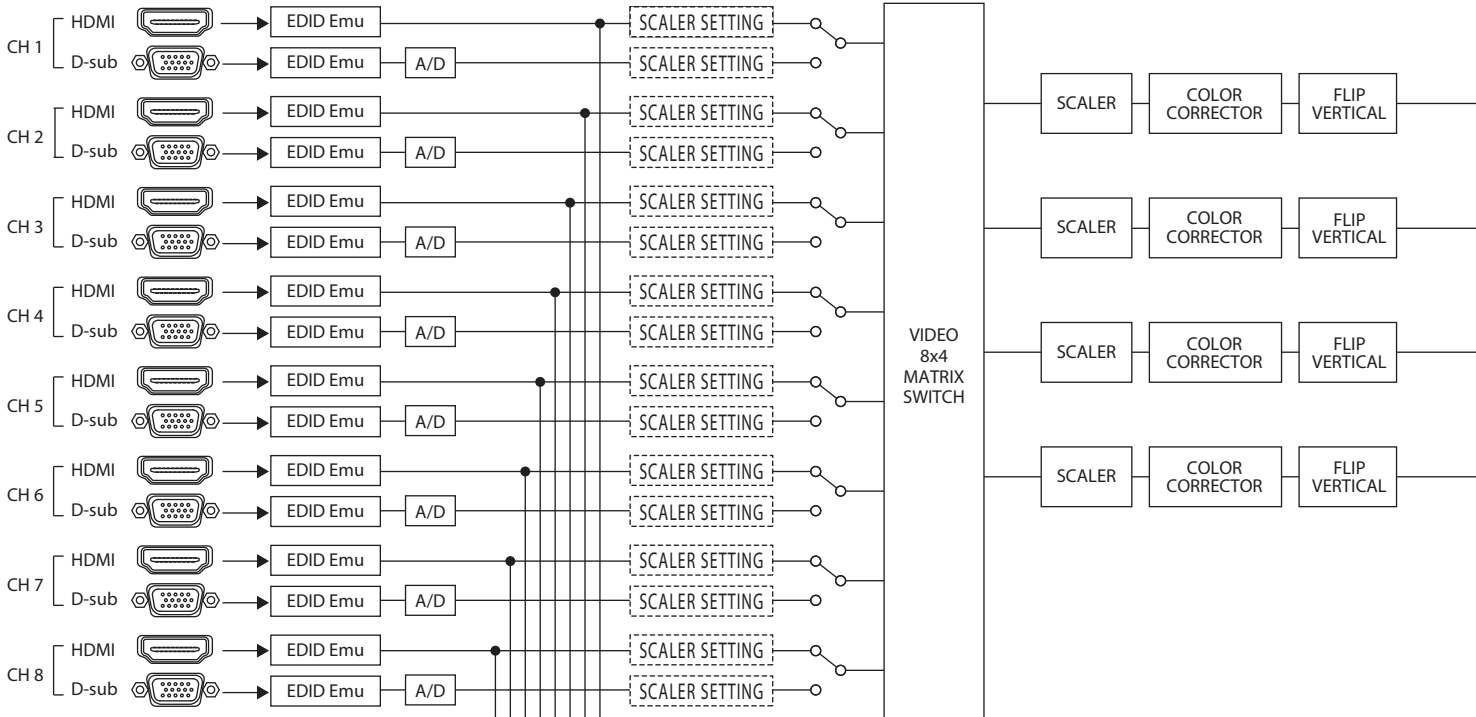

\* D-sub: Component, composite, and Y/C signals can be accommodated by using conversion cables.

AUDIO FOLLOW

## Audio Block

HDMI outputs (Audio) x 8  
De-Embedded  
AUDIO (8ch)

HDMI CH 1-8

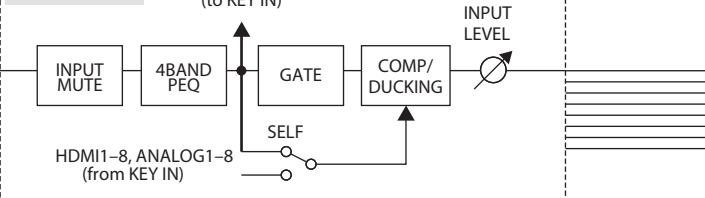

Analog Audio outputs x 8

Analog CH 1-8

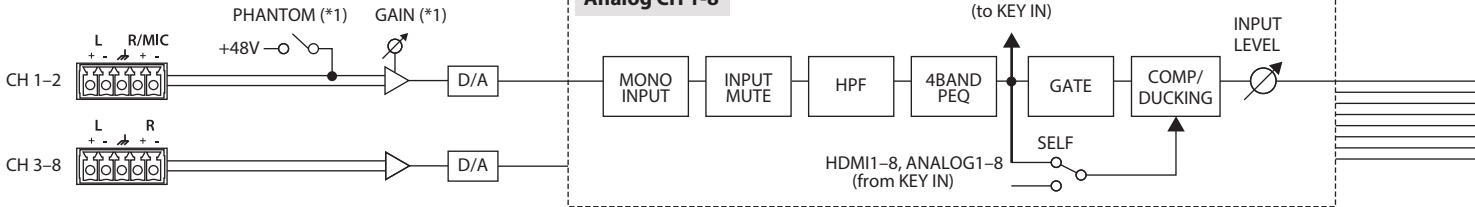

(\*1) Phantom power and gain are enabled only for the R channels of analog input channels 1 and 2.

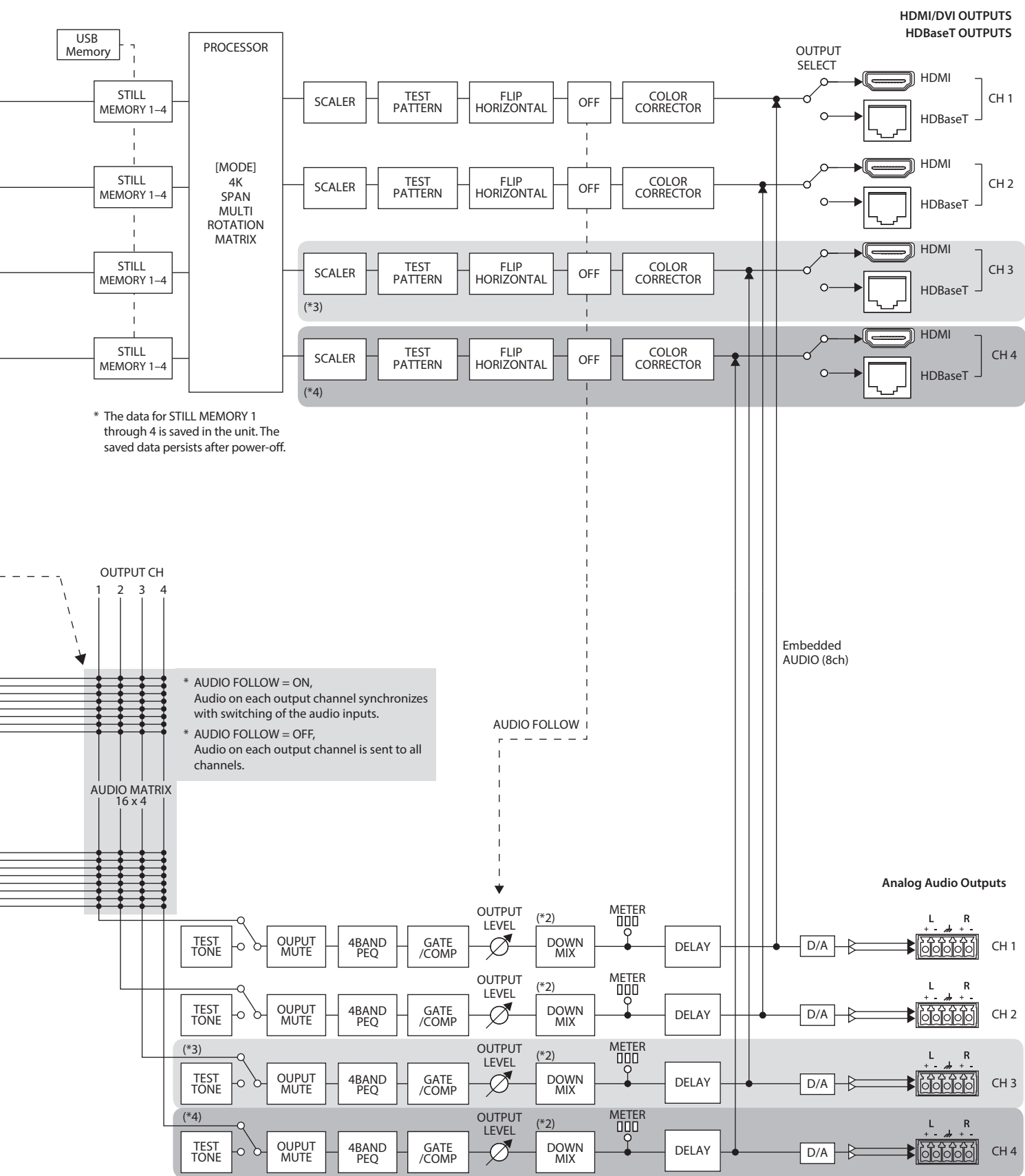

(\*2) DOWN MIX: From the menu, set "OFF," "STEREO > MONO," "5.1ch > STEREO," "5.1ch > MONO."

(\*3) : XS-83H and XS-84H only

(\*4) : XS-84H only

# Connector Specifications

## Analog video INPUT connectors

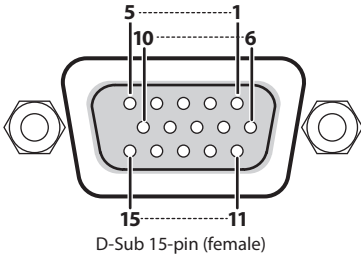

Pin No.	Input video signal type			
	RGB	Component	Composite	YC
1	Red	Pr/Cr		
2	Green/G on Sync	Y	VIDEO	Y
3	Blue	Pb/Cb		C
4				
5	GND			
6	GND	GND		
7	GND	GND	GND	GND
8	GND	GND		GND
9	DDC +5V			
10	GND			
11				
12	DDC data			
13	HD			
14	VD			
15	DDC clock			

## RS-232C connector

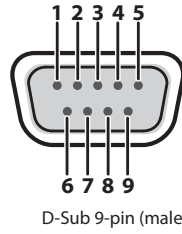

Pin No.	Signal
1	
2	RXD
3	TXD
4	DTR
5	GND
6	DSR
7	RTS
8	CTS
9	

<b>Communication method</b>	Synchronous (asynchronous), full-duplex
<b>Communication speed</b>	9600 bps/38400 bps
<b>Parity</b>	none
<b>Data length</b>	8 bit
<b>Stop bit</b>	1 bit
<b>Code set</b>	ASCII
<b>Flow Control</b>	XON/XOFF

## Cable Wiring Diagram

Wire the three lines of RXD, TXD, and GND as shown in the figure below.

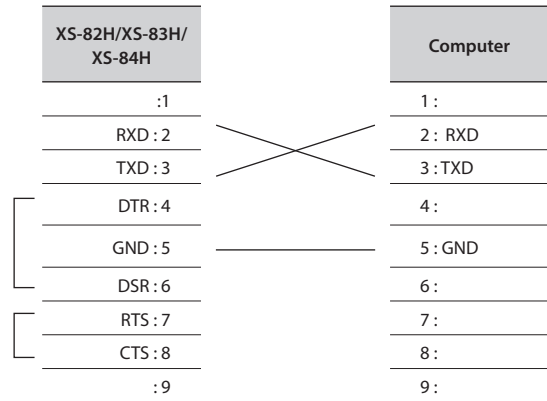

- \* The connections between 4 and 6 and between 7 and 8 are inside the unit.
- \* When connecting to a controlling device (such as an RS-232C-compatible computer), use a crossover cable.



## AUDIO INPUT/OUTPUT connectors

The AUDIO INPUT and OUTPUT connectors are wired as shown in the figure below.

Wire the cables correctly, according to whether you're using balanced or unbalanced connections.

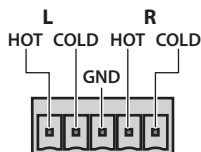

### TRS plug

#### Balanced connection

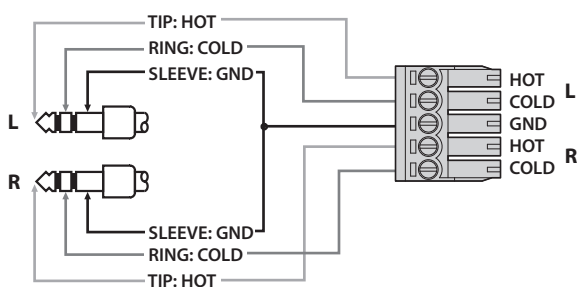

#### Unbalanced connection

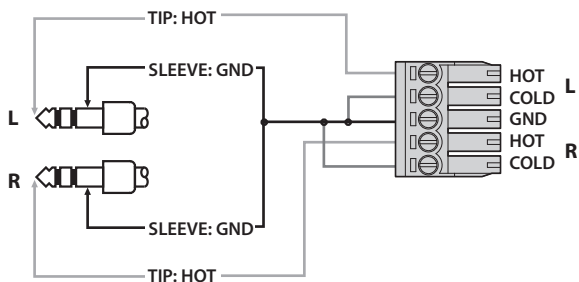

### XLR plug (female)

#### Balanced connection

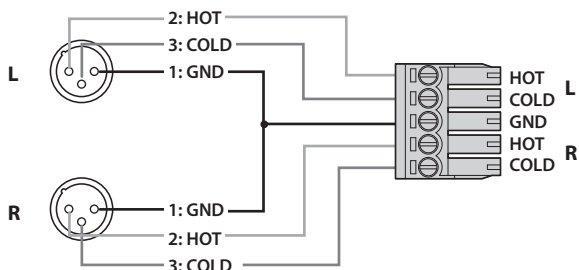

#### Unbalanced connection

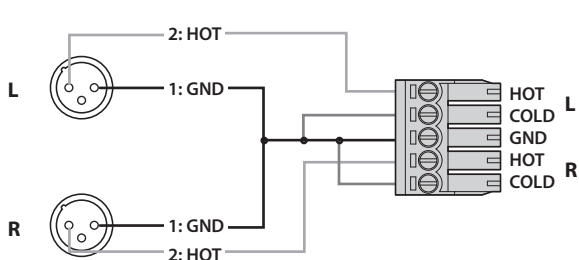

### RCA pin plug

#### Unbalanced connection

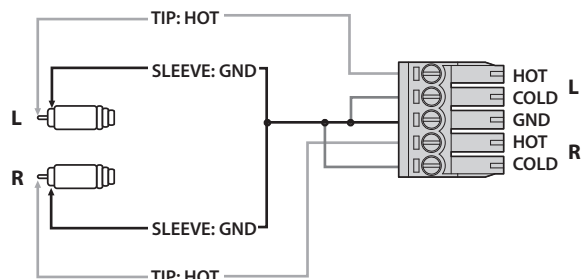

### Microphones

#### Balanced connection

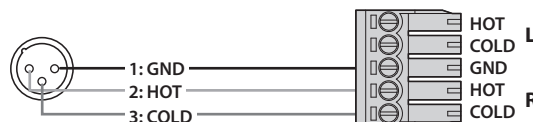

#### Unbalanced connection

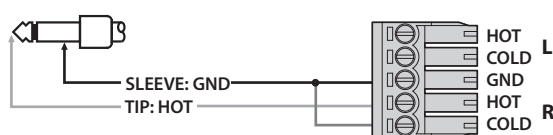

# Main Specifications

Video					
Video processing		4:4:4 (Y/Pb/Pr), 10-bit			
Input Connectors		HDMI	Type A (19 pins) x 8 (INPUT 1–8) * HDCP Supported		
		RGB/Component/Composite/S-Video	HD DB-15 type x 8 (INPUT 1–8)		
Output Connectors	XS-82H	HDMI	Type A (19 pins) x 2 (OUTPUT1–2)	* HDCP Supported	
		HDBaseT	RJ-45 x 2(OUTPUT1–2)		
	XS-83H	HDMI	Type A (19 pins) x 3 (OUTPUT1–3)	* HDCP Supported	
		HDBaseT	RJ-45 x 3(OUTPUT1–3)		
	XS-84H	HDMI	Type A (19 pins) x 4 (OUTPUT1–4)	* HDCP Supported	
		HDBaseT	RJ-45 x 4 (OUTPUT1–4)		
Input Level and Impedance		Analog RGB	0.7 Vp-p 75 ohms (H, V: 5 VTTL)		
		Analog HD	1.0 Vp-p 75 ohms (Sync-Signal: Bi-Level/Tri-Level)		
		Composite/S-Video	Signal Level	1.0 Vp-p (luminance), 0.286 Vp-p (chroma(NTSC)), 0.3 Vp-p (chroma(PAL))	
			Impedance	75 ohms	
Scan Convertor		INPUT	Aspect ratio control, Image adjustment function (Brightness, Contrast, Color adjustment, Display position, Size, Flip vertical) * Settings can be saved in memory for each input.		
		OUTPUT	Image adjustment function(Brightness, Contrast, Color adjustment, Display position, Size, Flip horizontal, Crop) * Settings can be saved in memory for each output.		
Input formats		HDMI	480/59.94i, 576/50i, 480/59.94p, 576/50p, 720/59.94p, 720/50p, 1080/59.94i, 1080/50i, 1080/59.94p, 1080/50p, 640 x 480/60 Hz, 800 x 600/60 Hz, 1024 x 768/60 Hz, 1280 x 768/60 Hz, 1280 x 1024/60 Hz, 1366 x 768/60 Hz, 1400 x 1050/60 Hz, 1600 x 1200/60 Hz, 1920 x 1080/60 Hz, 1920 x 1200/60 Hz		
			* The video signal frame rate must match with the unit's frame rate setting.		
			* Conforms to VESA DMT Version 1.0 Revision 11.		
		RGB/Component	480/59.94i, 576/50i, 480/59.94p, 576/50p, 720/59.94p, 720/50p, 1080/59.94i, 1080/50i, 1080/59.94p, 1080/50p, 640 x 480/60 Hz, 800 x 600/60 Hz, 1024 x 768/60 Hz, 1280 x 768/60 Hz, 1280 x 1024/60 Hz, 1366 x 768/60 Hz, 1400 x 1050/60 Hz, 1600 x 1200/60 Hz, 1920 x 1080/60 Hz, 1920 x 1200/60 Hz		
			* The video signal frame rate must match with the unit's frame rate setting.		
			* Conforms to VESA DMT Version 1.0 Revision 11.		
Composite	480i/59.94, 576i/50				
S-Video	480i/59.94, 576i/50				
Still Image	Windows Bitmap File (.bmp) * Maximum 1920 x 1200 pixels, 24-bit per pixel, uncompressed. It can be stored up to 4 files in the internal memory.				
Output formats		HDMI/HDBaseT	480/59.94i, 576/50i, 480/59.94p, 576/50p, 720/59.94p, 720/50p, 1080/59.94i, 1080/50i, 1080/59.94p, 1080/50p, 640 x 480/60 Hz, 800 x 600/60 Hz, 1024 x 768/60 Hz, 1280 x 768/60 Hz, 1280 x 1024/60 Hz, 1366 x 768/60 Hz, 1600 x 1200/60 Hz, 1920 x 1200/60 Hz		
			* The output refresh rates of 640 x 480–1366 x 768 are 75 Hz when the unit's frame rate setting is 50 Hz.		
			* Conforms to VESA DMT Version 1.0 Revision 11.		
			* 1920 x 1200/60Hz : Reduced blanking		
Video effects		Transition	Seamless switching (Seamless fade through black transition effects are available to enhance presentations by eliminating distractions during switching.)		
		Mode	Matrix, Multi (Up to 4 Windows),Span, Left and right 90 degrees rotation, 4K		
		Others	Flip vertical, Flip horizontal, Output fade, Test pattern output (Colorbar, Hatch,etc)		

Audio				
Audio processing		Sampling rate	24 bits/48 kHz, 8ch	
Input Connectors		Digital	HDMI Type A (19 pins) x 8	
		Analog	5-pin euroblock type x 8	
Output Connectors	XS-82H	Digital	HDMI Type A (19 pins) x 2	
		Analog	5-pin euroblock type x 2	
	XS-83H	Digital	HDMI Type A (19 pins) x 3	
		Analog	5-pin euroblock type x 3	
	XS-84H	Digital	HDMI Type A (19 pins) x 4	
		Analog	5-pin euroblock type x 4	
Input Level and Impedance		Ch1-2	Signal Level	-60 to +4 dBu (Maximum: +22 dBu)
			Impedance	Gain 0 to 23 = 10 k ohms, Gain 2 to 60 = 5 k ohms
		Ch3-8	Signal Level	+4 dBu (Maximum: +22 dBu)
			Impedance	8.5 k ohms
Output Level and Impedance		Ch1-4	Signal Level	+4 dBu (Maximum: +22 dBu)
			Impedance	600 ohms
Audio Formats		HDMI	Linear PCM, 24 bit, 48 kHz, 8 ch	
Audio Effects		16 stereo inputs and 4 outputs digital audio mixer		
		Input	High-pass filter, Mono, 4-band parametric equalizer, Compressor/Ducking, Gate	
		Output	4-band parametric equalizer, Compressor/Gate, Down mix, Lip-sync Delay (1 msec units, max 170 msec)	
		Other	Test tone output, Synchronized/unsynchronized audio and video function	
Other function				
Preset memory (32), Key lock function.				
Other jacks				
RS-232C		9 pins D-sub type x 1		
LAN		RJ-45 x 1		
USB		A type x 2 (for USB memories, for WNA1100-RL/ONKYO UWF-1)		
Display				
Graphic LCD 128 x 64 dots				
Others				
Power Supply		AC 117 V, AC 220 V, AC 230 V, AC 240 V (50/60 Hz)		
Power Consumption	XS-82H	55 W/0.5 A (117 V), 55 W/0.4 A (220 V, 230 V, 240 V)		
	XS-83H	60 W/0.6 A (117 V), 60 W/0.4 A (220 V, 230 V, 240 V)		
	XS-84H	70 W/0.6 A (117 V), 70 W/0.5 A (220 V, 230 V, 240 V)		
Dimensions		481(W) x 353(D) x 88(H) mm 18-15/16 (W) x 13-15/16 (D) x 3-1/2 (H) inches * EIA-2U rack mountable		
Weight		6.0 kg 13 lbs 4 oz		
Operation Temperature		+0 to +40 degrees Celsius +32 to +104 degrees Fahrenheit		
Accessories		Power Cord, Euroblock Plug x 12, Rubber Foot x 5, Owner's Manual		

\* 0 dBu=0.775 Vrms

\* In the interest of product improvement, the specifications and/or appearance of this unit are subject to change without prior notice.

\* This product is intended for use in the following Electromagnetic environments:

E1: residential, E2:commercial and light industrial, E3:urban outdoors, E4:controlled EMC environment, ex. recording studio (broadcasting studio) which are specified in EN55103-1 and EN55103-2.

# Dimensions

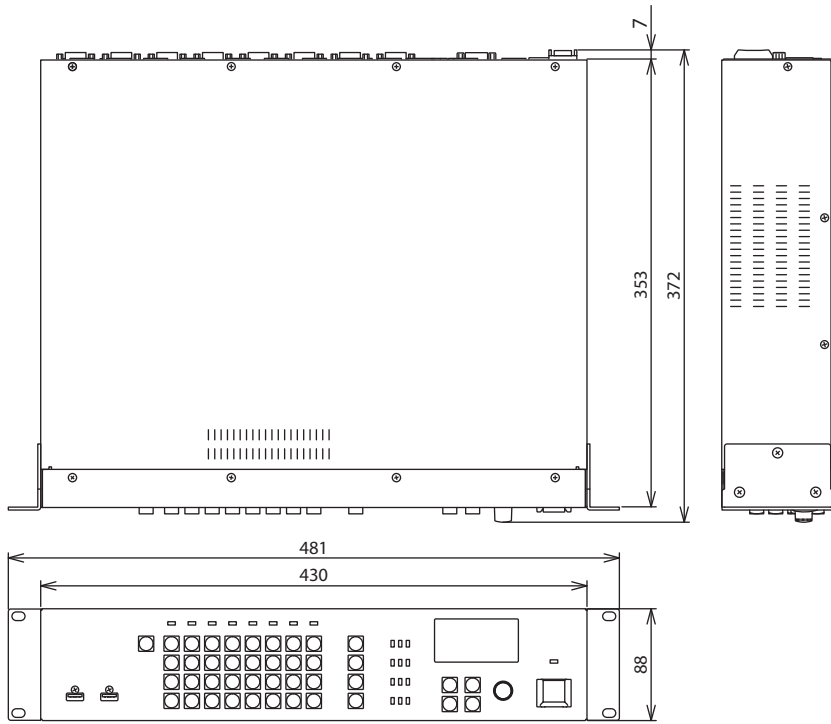

Unit: mm

MEMO

---

For the USA

## FEDERAL COMMUNICATIONS COMMISSION RADIO FREQUENCY INTERFERENCE STATEMENT

This equipment has been tested and found to comply with the limits for a Class B digital device, pursuant to Part 15 of the FCC Rules. These limits are designed to provide reasonable protection against harmful interference in a residential installation. This equipment generates, uses, and can radiate radio frequency energy and, if not installed and used in accordance with the instructions, may cause harmful interference to radio communications. However, there is no guarantee that interference will not occur in a particular installation. If this equipment does cause harmful interference to radio or television reception, which can be determined by turning the equipment off and on, the user is encouraged to try to correct the interference by one or more of the following measures:

- Reorient or relocate the receiving antenna.
- Increase the separation between the equipment and receiver.
- Connect the equipment into an outlet on a circuit different from that to which the receiver is connected.
- Consult the dealer or an experienced radio/TV technician for help.

This device complies with Part 15 of the FCC Rules. Operation is subject to the following two conditions:

- (1) this device may not cause harmful interference, and
- (2) this device must accept any interference received, including interference that may cause undesired operation.

This equipment requires shielded interface cables in order to meet FCC class B limit.

Any unauthorized changes or modifications not expressly approved by the party responsible for compliance could void the user's authority to operate the equipment.

For Canada

CAN ICES-3 (B)/NMB-3 (B)

For Korea

### 사용자 안내문

기종별	사용자 안내문
B 급 기기 (가정용 방송통신기자재)	이 기기는 가정용(B 급) 전자파적합기기로서 주로 가정에서 사용하는 것을 목적으로 하며, 모든지역에서 사용할 수 있습니다.

For C.A. US (Proposition 65)

### WARNING

This product contains chemicals known to cause cancer, birth defects and other reproductive harm, including lead.



For the USA

## DECLARATION OF CONFORMITY Compliance Information Statement

Model Name : XS-82H/XS-83H/XS-84H  
 Type of Equipment : Video Switcher  
 Responsible Party : Roland Corporation U.S.  
 Address : 5100 S. Eastern Avenue Los Angeles, CA 90040-2938  
 Telephone : (323) 890-3700

For EU Countries



This product is intended for use in the following Electromagnetic environments:

E1: residential, E2: commercial and light industrial, E3: urban outdoors, E4: controlled EMC environment, ex. recording studio (broadcasting studio) which are specified in EN55103-1 and EN55103-2.

**For EU Countries**



- UK** This symbol indicates that in EU countries, this product must be collected separately from household waste, as defined in each region. Products bearing this symbol must not be discarded together with household waste.
- DE** Dieses Symbol bedeutet, dass dieses Produkt in EU-Ländern getrennt vom Hausmüll gesammelt werden muss gemäß den regionalen Bestimmungen. Mit diesem Symbol gekennzeichnete Produkte dürfen nicht zusammen mit dem Hausmüll entsorgt werden.
- FR** Ce symbole indique que dans les pays de l'Union européenne, ce produit doit être collecté séparément des ordures ménagères selon les directives en vigueur dans chacun de ces pays. Les produits portant ce symbole ne doivent pas être mis au rebut avec les ordures ménagères.
- IT** Questo simbolo indica che nei paesi della Comunità europea questo prodotto deve essere smaltito separatamente dai normali rifiuti domestici, secondo la legislazione in vigore in ciascun paese. I prodotti che riportano questo simbolo non devono essere smaltiti insieme ai rifiuti domestici. Ai sensi dell'art. 13 del D.Lgs. 25 luglio 2005 n. 151.
- ES** Este símbolo indica que en los países de la Unión Europea este producto debe recogerse aparte de los residuos domésticos, tal como está regulado en cada zona. Los productos con este símbolo no se deben depositar con los residuos domésticos.
- PT** Este símbolo indica que nos países da UE, a recolha deste produto deverá ser feita separadamente do lixo doméstico, de acordo com os regulamentos de cada região. Os produtos que apresentem este símbolo não deverão ser eliminados juntamente com o lixo doméstico.
- NL** Dit symbool geeft aan dat in landen van de EU dit product gescheiden van huishoudelijk afval moet worden aangeboden, zoals bepaald per gemeente of regio. Producten die van dit symbool zijn voorzien, mogen niet samen met huishoudelijk afval worden verwijderd.
- DK** Dette symbol angiver, at i EU-lande skal dette produkt opsamles adskilt fra husholdningsaffald, som defineret i hver enkelt region. Produkter med dette symbol må ikke smides ud sammen med husholdningsaffald.
- NO** Dette symbolet indikerer at produktet må behandles som spesialavfall i EU-land, iht. til retningslinjer for den enkelte regionen, og ikke kastes sammen med vanlig husholdningsavfall. Produkter som er merket med dette symbolet, må ikke kastes sammen med vanlig husholdningsavfall.

- SE** Symbolen anger att i EU-länder måste den här produkten kasseras separat från hushållsavfall, i enlighet med varje regions bestämmelser. Produkter med den här symbolen får inte kasseras tillsammans med hushållsavfall.
- FI** Tämä merkintä ilmaisee, että tuote on EU-maissa kerättävä erillään kotitalousjätteistä kunkin alueen voimassa olevien määräysten mukaisesti. Tällä merkinnällä varustettuja tuotteita ei saa hävittää kotitalousjätteiden mukana.
- HU** Ez a szimbólum azt jelenti, hogy az Európai Unióban ezt a terméket a háztartási hulladéktól elkülönítve, az adott régióban érvényes szabályozás szerint kell gyűjteni. Az ezzel a szimbóllummal ellátott termékeket nem szabad a háztartási hulladék közé dobni.
- PL** Symbol oznacza, że zgodnie z regulacjami w odpowiednim regionie, w krajach UE produktu nie należy wyrzucać z odpadami domowymi. Produktów opatrzonych tym symbolem nie można utylizować razem z odpadami domowymi.
- CZ** Tento symbol udává, že v zemích EU musí být tento výrobek sbírán odděleně od domácího odpadu, jak je určeno pro každý region. Výrobky nesoucí tento symbol se nesmí vyhazovat spolu s domácím odpadem.
- SK** Tento symbol vyjadruje, že v krajinách EÚ sa musí zber tohto produktu vykonávať oddelene od domového odpadu, podľa nariadení platných v konkrétnej krajine. Produkty s týmto symbolom sa nesmú vyhazovať spolu s domovým odpadom.
- EE** See sümbol näitab, et EL-i maades tuleb see toode olemprigust eraldi koguda, nii nagu on igas piirkonnas määratletud. Selle sümboliga märgitud tooteid ei tohi ära visata koos olmeprügiga.
- LT** Šis simbolis rodo, kad ES šalyse šis produktas turi būti surenkamas atskirai nuo buitinių atliekų, kaip nustatyta kiekviename regione. Šiuo simboliu paženklinoti produktai neturi būti išmetami kartu su buitiniems atliekomis.
- LV** Šis simbols norāda, ka ES valstīs šo produktu jāievāc atsevišķi no mājsaimniecības atkritumiem, kā noteikts katrā reģionā. Produkta ar šo simbolu nedrīkst izmest kopā ar mājsaimniecības atkritumiem.
- SI** Ta simbol označuje, da je treba proizvod v državah EU zbirati ločeno od gospodinskih odpadkov, tako kot je določeno v vsaki regiji. Proizvoda s tem znakom ni dovoljeno odlagati skupaj z gospodinskimi odpadki.
- GR** Το σύμβολο αυτό υποδηλώνει ότι στις χώρες της Ε.Ε. το συγκεκριμένο προϊόν πρέπει να συλλέγεται χωριστά από τα υπόλοιπα οικιακά απορρίμματα, σύμφωνα με όσα προβλέπονται σε κάθε περιοχή. Τα προϊόντα που φέρουν το συγκεκριμένο σύμβολο δεν πρέπει να απορρίπτονται μαζί με τα οικιακά απορρίμματα.

**For China**

## 有关产品中所含有害物质的说明

本资料就本公司产品中所含的特定有害物质及其安全性予以说明。  
本资料适用于 2007 年 3 月 1 日以后本公司所制造的产品。

### 环保使用期限



此标志适用于在中国国内销售的电子信息产品，表示环保使用期限的年数。所谓环保使用期限是指在自制造日起的规定期限内，产品中所含的有害物质不致引起环境污染，不会对人身、财产造成严重的不良影响。环保使用期限仅在遵照产品使用说明书，正确使用产品的条件下才有效。不当的使用，将会导致有害物质泄漏的危险。

### 产品中有毒有害物质或元素的名称及含量

部件名称	有毒有害物质或元素					
	铅(Pb)	汞(Hg)	镉(Cd)	六价铬(Cr(VI))	多溴联苯(PBB)	多溴二苯醚(PBDE)
外壳(壳体)	×	○	○	○	○	○
电子部件(印刷电路板等)	×	○	×	○	○	○
附件(电源线、交流适配器等)	×	○	○	○	○	○

○：表示该有毒有害物质在该部件所有均质材料中的含量均在 SJ/T11363-2006 标准规定的限量要求以下。  
×：表示该有毒有害物质至少在该部件的某一均质材料中的含量超出 SJ/T11363-2006 标准规定的限量要求。  
因根据现有的技术水平，还没有什么物质能够代替它。



 Roland

